

SONY®

# User guide

Xperia L3  
I3312/I4312/I4332

# Contents

<b>Getting started</b> .....	<b>5</b>
About this User guide.....	5
Overview.....	6
Assembly - Single SIM.....	7
Assembly - Dual SIM.....	8
Screen protection.....	9
Starting your device for the first time.....	9
Why do I need a Google account?.....	9
Transferring content from your old device.....	10
<b>Device security</b> .....	<b>11</b>
Making sure your device is protected.....	11
Screen lock.....	11
Fingerprint Manager .....	12
SIM card protection.....	13
Using Dual SIM devices.....	13
Finding the IMEI number(s) of your device.....	14
Finding, locking or erasing a lost device .....	14
Using location services.....	15
<b>Learning the basics</b> .....	<b>16</b>
Using the touchscreen.....	16
Turning the screen on or off.....	18
Home screen.....	18
Application screen.....	20
Navigating applications.....	21
Widgets.....	23
Shortcuts and folders.....	24
Background.....	25
Taking a screenshot.....	25
Notifications.....	26
Icons in the status bar.....	28
<b>Battery and maintenance</b> .....	<b>30</b>
Charging your device.....	30
Battery and power management.....	31
Updating your device.....	32
Restarting, resetting and repairing.....	33
Improving memory performance.....	34
<b>Backing up and synchronising data</b> .....	<b>36</b>
Backing up and synchronising with a Google account .....	36
Backing up and transferring data using a computer.....	37

Backing up and transferring data using a memory card .....	37
Synchronising with Microsoft Exchange ActiveSync.....	37
<b>Downloading applications.....</b>	<b>39</b>
Downloading applications on Google Play.....	39
Downloading applications from other sources.....	39
<b>Internet and networks.....</b>	<b>40</b>
Internet and MMS settings .....	40
Wi-Fi .....	40
Sharing your mobile data connection.....	42
Controlling data usage.....	44
Selecting a SIM card for data traffic.....	44
Selecting mobile networks.....	45
<b>Basic settings.....</b>	<b>46</b>
Accessing settings.....	46
Volume, vibration and sound.....	46
Silence your device with Do not disturb.....	47
Screen settings.....	48
Screen pinning.....	49
Application settings.....	50
Resetting your applications.....	51
Language settings.....	51
Date and time.....	52
Multiple user accounts.....	52
<b>Typing text.....</b>	<b>53</b>
On-screen keyboards.....	53
Editing text.....	54
<b>Calling.....</b>	<b>55</b>
Making calls.....	55
Receiving calls.....	56
Forwarding calls.....	57
Blocking a number.....	58
<b>Contacts.....</b>	<b>59</b>
Adding and editing contacts.....	59
Grouping contacts.....	60
Transferring contacts.....	60
Backing up contacts.....	61
<b>Messaging and chat.....</b>	<b>63</b>
Reading and sending messages.....	63
Messaging settings.....	64
Setting up email.....	65

<b>Music and FM radio.....</b>	<b>66</b>
Transferring music from a computer to your device .....	66
Listening to music.....	66
Listening to the radio.....	68
<b>Camera.....</b>	<b>70</b>
Getting to know your camera.....	70
Exposure, colour and light conditions.....	73
People, selfies and smiling faces.....	74
Portrait selfie.....	75
Bokeh effect.....	75
Using various capturing modes.....	75
Resolution and memory.....	77
Additional camera settings.....	77
<b>Photos and videos in Album.....</b>	<b>79</b>
Viewing photos and videos.....	79
Album home screen menu.....	79
<b>Connectivity.....</b>	<b>81</b>
Connecting your device to USB accessories.....	81
NFC (Near Field Communication).....	81
Bluetooth wireless technology.....	83
<b>Smart apps and features that save you time.....</b>	<b>86</b>
Using your device as a wallet.....	86
<b>Clock and Calendar.....</b>	<b>87</b>
Calendar.....	87
Clock.....	87
<b>Accessibility.....</b>	<b>90</b>
Magnification.....	90
Font size.....	90
Display size.....	90
Colour correction.....	90
Mono audio.....	91
<b>Support application.....</b>	<b>92</b>
About the Support app.....	92
<b>Legal information.....</b>	<b>93</b>
General.....	93
Warranty, SAR, and usage guidelines.....	93

# Getting started

## About this User guide

This is the Xperia L3 User guide for the Android™ 8.1 software version. If you're not sure which software version your device is running, you can check it in the Settings menu.

### Note

System and application updates can present the features in your device in another way than described in this User guide. The Android version might not be affected in an update. For more information about software updates, see *Updating your device* on page 32.

### To check the current software version and model number of your device

- Find and tap **Settings > System > About phone**. The current software version is displayed under Build number. The current model number is displayed under Model.

## Limitations to services and features

Some of the services and features described in this User guide may not be supported in all countries or regions, or by all networks or service providers. The GSM International Emergency Number can always be used in all countries, regions, networks and by all service providers, provided that the device is connected to the mobile network. Please contact your network operator or service provider to determine the availability of any specific service or feature and whether additional access or usage fees apply.

The use of certain features and applications described in this guide may require access to the internet. You may incur data connection charges when you connect to the internet with your device. Contact your wireless service provider for more information.

## Overview

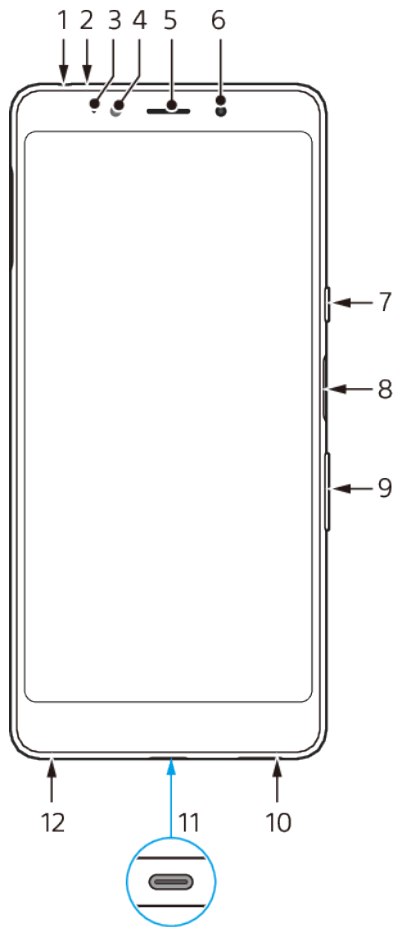

- 1 Headset jack
- 2 Second microphone
- 3 Charging/Notification light
- 4 Front camera
- 5 Ear speaker
- 6 Proximity/Light sensor
- 7 Power key
- 8 Fingerprint sensor
- 9 Volume/Zoom key
- 10 Speaker
- 11 USB port/Charger
- 12 Primary microphone

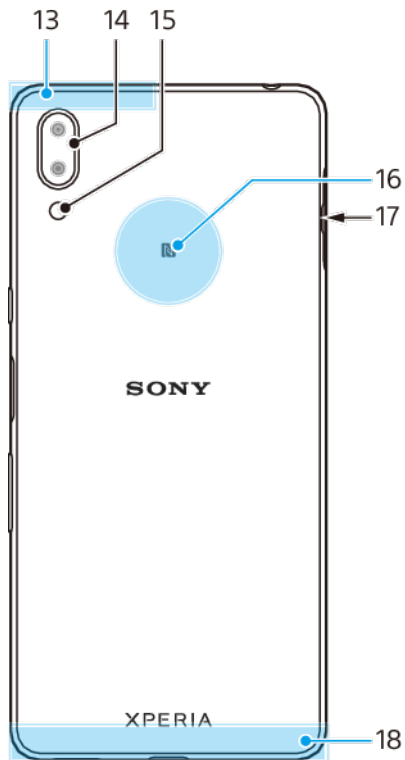

- 13 Wi-Fi/Bluetooth®/GPS antenna
- 14 Dual camera
- 15 Flash LED
- 16 NFC™ detection area
- 17 Nano SIM/Memory card slot
- 18 Main antenna

## Assembly - Single SIM

Your device only supports nano SIM cards. Single SIM devices allow you to use one SIM card and a memory card.

The SIM and memory cards go in different parts of the nano SIM and memory card tray. Make sure you don't confuse the two.

For information on how to check if your device is Single SIM or Dual SIM, see *Finding the IMEI number(s) of your device* on page 14.

**Note**

To prevent data loss, make sure you turn off your device or unmount the memory card before you drag out the holder to remove the nano SIM card or memory card from the device.

## To insert a nano SIM card and a memory card

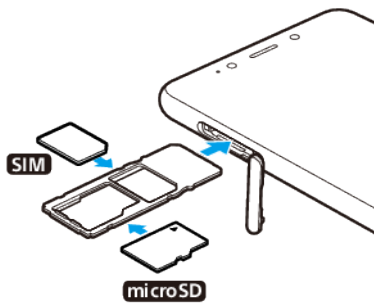

### Note

Do not cut your SIM card, as this may damage your device.

- 1 Open the slot cover.
- 2 Drag out the card tray.
- 3 Place the SIM card securely in the SIM card tray.
- 4 Place the memory card securely in the memory card tray.
- 5 Gently push the card tray back into the slot until it fits into place.
- 6 Close the slot cover.

## Assembly - Dual SIM

Your device only supports nano SIM cards. Dual SIM devices support the use of one or two nano SIM cards and a memory card.

Dual SIM devices are not available in all markets or from all operators.

For information on how to check if your device is Single SIM or Dual SIM, see *Finding the IMEI number(s) of your device* on page 14.

### Note

To prevent data loss, make sure you turn off your device or unmount the memory card before you drag out the holder to remove the nano SIM card (or cards) or memory card from the device.

## To insert the nano SIM cards and the memory card

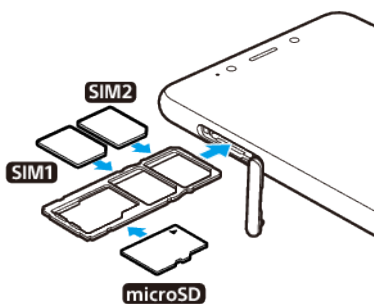

### Note

Do not cut your SIM card, as this may damage your device.

- 1 Open the slot cover.
- 2 Drag out the card tray.



- 3 Insert the memory card in the correct orientation into the memory card slot.
- 4 Place the main SIM card (SIM1) securely in the SIM card tray.
- 5 Place the second SIM card (SIM2) securely in the SIM card tray.
- 6 Place the memory card securely in the memory card tray.
- 7 Gently push the card tray back into the slot until it fits into place.
- 8 Close the slot cover.

## Screen protection

### Note

Before using your device, remove all protection films to enable full functionality.

Screen covers and protectors may help you protect your device against damage. We recommend you use only those screen covers intended for your Xperia device. The use of third-party screen protection accessories may prevent your device from working correctly by covering sensors, lenses, speakers, or microphones and can invalidate the warranty.

## Starting your device for the first time

It is recommended that you charge the battery for at least 30 minutes before starting up your device for the first time. You can still use your device while it is charging. For more information on charging, see *Charging your device* on page 30.

The first time you start your device, a setup guide helps you to configure basic settings, personalise your device, and sign in to your accounts, for example a Google™ account.

### To turn on your device

- 1 Long press the power key until your device vibrates.
- 2 Enter your SIM card PIN when requested, then tap ✓ (Done icon).
- 3 Wait a moment for your device to start.

### Hint

Your SIM card PIN is initially supplied by your network operator, but you can change it later from the Settings menu. To correct a mistake made while entering your SIM card PIN, tap ✕ (Backspace icon).

### To turn off the device

- 1 Long press the power key until the options menu opens.
- 2 Tap **Power off**.

### Note

It may take a while for the device to shut down.

## Why do I need a Google account?

Your device from Sony runs on the Android platform developed by Google. A range of Google applications and services is available on your device when you purchase it, for example, Gmail™, Google Maps™, YouTube™, and the Google Play application. To get the most out of these services, you need a Google account. For example, a Google account enables you to do the following:

- Download and install applications on Google Play.
- Synchronise your email, contacts, and calendar using Gmail.
- You can back up, restore and transfer your data from an old device to your new device.
- Chat with friends using the Google Duo™ application.

- Synchronise your browsing history and bookmarks using the Google Chrome™ web browser.
- Identify yourself as the authorised user after a software repair using Xperia Companion.
- Remotely find, lock, or clear a lost or stolen device using the Find my device services.

For more information about Android and Google, go to <http://support.google.com>.

### To set up a Google account on your device

- 1 Find and tap **Settings > Users & accounts > Add account > Google**.
- 2 Follow the on-screen instructions to create a Google account, or sign in if you already have an account.

## Transferring content from your old device

There are several ways to transfer your data from an old device to your new device.

- Synchronise data using Google account
- Copy and transfer data using a computer
- Copy and transfer data using an SD card

### Synchronising data using a Google account

You can transfer data by synchronising with a Google account. First, back up your data to the Google server from your old phone using your Google account. Then, set the same Google account on your new device. Depending on which contents to backup and synchronise, there are several ways.

- Gmail, Calendar, Contacts: Log in with the same Google account that you were using on your old device. Then, your Gmail, Calendar, and Contacts will be automatically synchronised with your Google account.
- Image (photo), video: Back up your data from the old device to the Google server using Google Photos. Then, synchronise with your Google account on the new device.
- Applications, setting, call history: Back up automatically using Google Drive on your old device. Then, synchronise with your Google account on your new device.
- Music and other document files: Manually back up your media files from the old device using Google Drive. Then, synchronise with your Google account on the new device.

For more information, see *Backing up and synchronising with a Google account* on page 36.

### Transferring data using a computer

If you are storing large volumes of data on your device, you can transfer your data using a computer. For more information, see *Backing up and transferring data using a computer* on page 37.

### Transferring data using an SD card

You can transfer media files and contacts using an SD card. For more information, see *Backing up and transferring data using a memory card* on page 37.

# Device security

## Making sure your device is protected

Your device includes security options, strongly recommended in case of loss or theft.

### Note

When using a security option to protect your device, it is crucial to remember the details provided at set up.

## Screen lock

Set a secure screen lock on your device using a PIN, password, pattern, or fingerprint to prevent others from using your device without permission. Once the screen lock is set, it is not possible to unlock the screen or erase the content via a Factory data reset without providing the screen lock information.

## Find my device

Use the Find my device service to remotely locate, lock, unlock, or erase the content on a lost device. After you have signed in to your Google account, Find my device is turned on by default.

## SIM card lock

Lock your SIM cards with a PIN to protect your subscription against misuse. The PIN is required every time you restart your device.

## IMEI number

Keep a copy of the IMEI number. If your device is stolen, some network providers can use this number to stop the device from accessing the network in your country or region.

## Backup

Back up the content on your device in case your device is damaged, lost or stolen.

- To back up with a Google account, see *Backing up and synchronising with a Google account* on page 36.
- To back up using a computer, see *Backing up and transferring data using a computer* on page 37.
- To back up using a memory card, see *Backing up and transferring data using a memory card* on page 37.

## Screen lock

When the screen is locked you have to unlock it with a swipe gesture or with your personal pattern, PIN, password or fingerprint. Initially, the unprotected screen swipe is set, but it is recommended to use a more secure screen lock to protect your device.

The security level of each lock type is listed below in order of weakest to strongest:

- **Swipe:** no protection, but you have quick access to the Home screen.
- **Pattern:** draw a simple pattern with your finger to unlock your device.
- **PIN:** enter a numeric PIN of at least four digits to unlock your device.

- **Password:** enter an alpha-numeric password to unlock your device.
- **Fingerprint:** place your registered finger on the sensor to unlock your device.

**Hint**

The Smart Lock feature lets you set your device to unlock automatically in certain situations, such as when connected to a Bluetooth device or carrying your device with you. Go to <http://www.support.google.com/> and search "smart lock" for more information.

### To create or change a screen lock

**Note**

It is very important that you remember your screen lock when using a pattern, PIN or password. If you forget this information, it may not be possible to restore important data such as contacts and messages.

- 1 Find and tap **Settings > Lock screen & security > Screen lock**.
- 2 If requested, confirm your current screen lock.
- 3 Choose an option and follow the on-screen instructions.
- 4 When a secure screen lock is used, you can set the power key to lock the screen, set the screen lock activation time and create a lock screen message by tapping  (Settings icon).

**Hint**

If you use a Microsoft® Exchange ActiveSync® (EAS) account, the EAS security settings may limit the lock screen type to only a PIN or password. Contact your network administrator to check the implemented network security policies.

## Fingerprint Manager

Register your fingerprint to use it as an additional security method for unlocking your device or authenticating purchases. You can register up to 5 fingerprints on your device.

The pattern, PIN, or password screen lock serves as a backup unlock method when a fingerprint is used as a screen lock. Before registering your fingerprint, make sure the sensor is clean and without any visible moisture.

### To register a fingerprint for the first time

- 1 Find and tap **Settings > Lock screen & security > Fingerprint Manager**.
- 2 Tap **Next**. If prompted confirm your pattern, PIN, or password, or select your backup screen lock method and follow the on-screen instructions to set it up.
- 3 Follow the on-screen instructions to complete fingerprint registration.

### To register additional fingerprints

- 1 Find and tap **Settings > Lock screen & security > Fingerprint Manager**.
- 2 Confirm your pattern, PIN, or password.
- 3 Tap **Add fingerprint**, then follow the on-screen instructions.

### To delete a registered fingerprint

- 1 Find and tap **Settings > Lock screen & security > Fingerprint Manager**.
- 2 Confirm your pattern, PIN, or password.
- 3 Tap  (Delete icon) to delete the fingerprint.

### To rename a registered fingerprint

- 1 Find and tap **Settings > Lock screen & security > Fingerprint Manager**.
- 2 Select a registered fingerprint in the list, then enter a name and tap **OK**.

## SIM card protection

You can lock and unlock each SIM card that you use in your device with a PIN. When a SIM card is locked, the subscription linked to the card is protected against misuse, meaning that you have to enter a PIN every time you start your device.

If you enter the PIN incorrectly too many times, your SIM card will get blocked. You then need to enter your PUK (Personal Unblocking Key) and a new PIN. Your PIN and PUK are supplied by your network operator.

### To set up a SIM card lock

- 1 Find and tap **Settings** > **Lock screen & security** > **SIM card lock**.
- 2 Dual SIM users, select a SIM card.
- 3 Tap the **Lock SIM card** switch to enable.
- 4 Enter the SIM card PIN and tap **OK**. The SIM card lock is now active and you will be prompted to enter your PIN every time you restart your device.

### To change the SIM card PIN

- 1 Find and tap **Settings** > **Lock screen & security** > **SIM card lock**.
- 2 Dual SIM users, select a SIM card.
- 3 Tap **Change SIM PIN**.
- 4 Enter the old SIM card PIN and tap **OK**.
- 5 Enter the new SIM card PIN and tap **OK**.
- 6 Re-type the new SIM card PIN and tap **OK**.

### To unlock a blocked SIM card using the PUK code

- 1 Enter the PUK code and tap ✓ (Done icon).
- 2 Enter a new PIN code and tap ✓ (Done icon).
- 3 Re-enter the new PIN code and tap ✓ (Done icon).

#### Note

If you enter an incorrect PUK code too many times, you need to contact your network operator to get a new SIM card.

## Using Dual SIM devices

If you are using a Dual SIM device, it works with either one or two SIM cards inserted. You can get incoming communication to both SIM cards and select which number to place outgoing communication from. Before using multiple SIM cards, you need to enable them and select a SIM card which will handle data traffic.

You can forward calls that come in on SIM 1 to SIM 2 when SIM 1 is unreachable, and vice versa. This function is called Dual SIM reachability. You must enable it manually. See *Forwarding calls* on page 57.

### To enable or disable the use of two SIM cards

- 1 Find and tap **Settings** > **Network & Internet** > **Dual SIM**.
- 2 Tap the SIM card switches to enable or disable the SIM cards.

### To rename a SIM card

- 1 Find and tap **Settings** > **Network & Internet** > **Dual SIM**.
- 2 Select a SIM card and enter a new name for it.
- 3 Tap **OK**.

### To select which SIM card handles data traffic

- 1 Find and tap **Settings** > **Network & Internet** > **Dual SIM** > **Mobile data**.
- 2 Select the SIM card you want to use for data traffic.

## Finding the IMEI number(s) of your device

Your device has one or two unique identification numbers that are referred to as IMEI or Product ID. You should keep a copy of this. You may require it if your device is stolen or when contacting support.

### To view your IMEI number(s) using the dialpad

- 1 Find and tap ☎ (Phone icon).
- 2 Tap ☎ (Dialpad icon).
- 3 Enter **\*#06#** into the dialpad. The IMEI number(s) are displayed automatically.

### To view your IMEI number(s) on the label strip

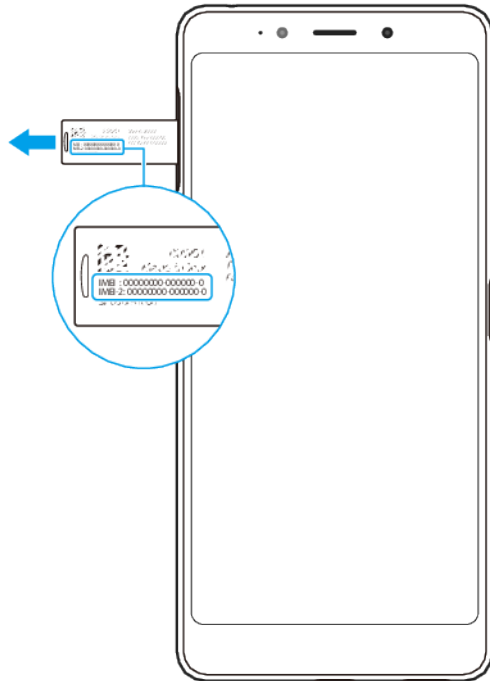

- 1 Open the slot cover and drag out the card tray.
- 2 Drag the strip outwards using your fingernail. The strip displays the IMEI number(s).

## Finding, locking or erasing a lost device

Google offers a location and security web service called Find my device. After you have signed in to a Google account, Find my device is turned on by default. If you lose your device, you can use Find my device to:

- Find and show where your device is located on a map.
- Lock your device and present a message on the lock screen.
- Unlock your device and reset it by erasing its content.
- Activate the ringer, even if the sound is turned off.

Your device must be turned on, have an internet connection, and have the location service activated. The Find my device service may not be available in all countries or regions.

For additional information about Find my device, go to <https://support.google.com/> and search for "Find my device."

### To verify that your device can be found

- Go to <https://www.google.com/android/find> and sign in using your Google account.

## Using location services

Location services allow applications such as Maps and the camera to use information from your mobile or Wi-Fi network as well as GPS (Global Positioning System) information to determine your approximate location. If you're not within a clear line of sight to GPS satellites, your device can determine your location using the Wi-Fi function. And if you're not within range of a network, your device can determine your location using your mobile network.

In order to use your device to find out where you are, you need to enable location services.

### To enable or disable location services

- 1 Find and tap **Settings > Lock screen & security > Location**.
- 2 Tap the switch to enable or disable location services.

## Improving GPS accuracy

The first time you use the GPS function in your device, it can take a few minutes for your location to be found. To help the search, make sure you have a clear view of the sky. Stand still and don't cover the GPS antenna. GPS signals can pass through clouds and plastic, but not through most solid objects such as buildings and mountains. If your location isn't found after a few minutes, move to another location.



# Learning the basics

## Using the touchscreen

### Tapping

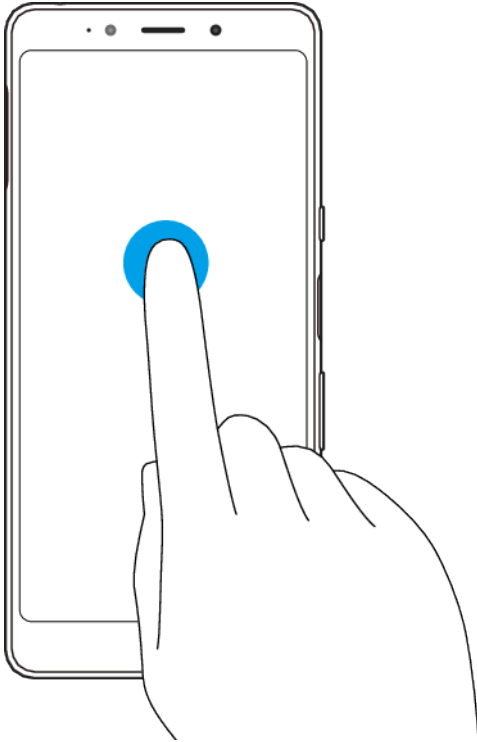

- Open or select an item.
- Mark or unmark a checkbox or option.
- Enter text using the on-screen keyboard.



## Touching and holding

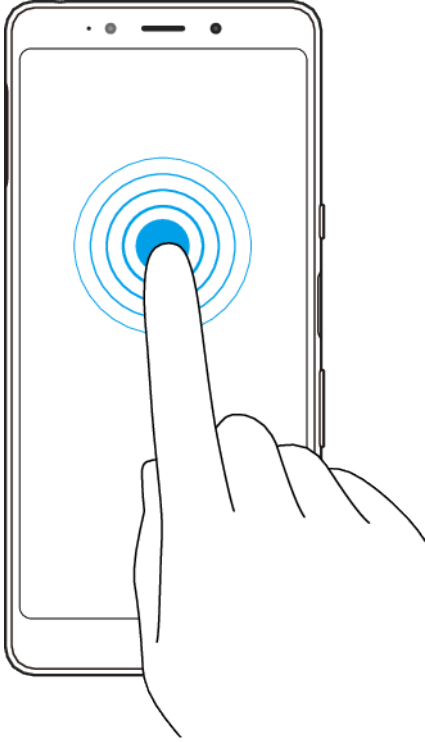

- Move an item.
- Activate selection mode, for example, to select several items from a list.

## Pinching in and out

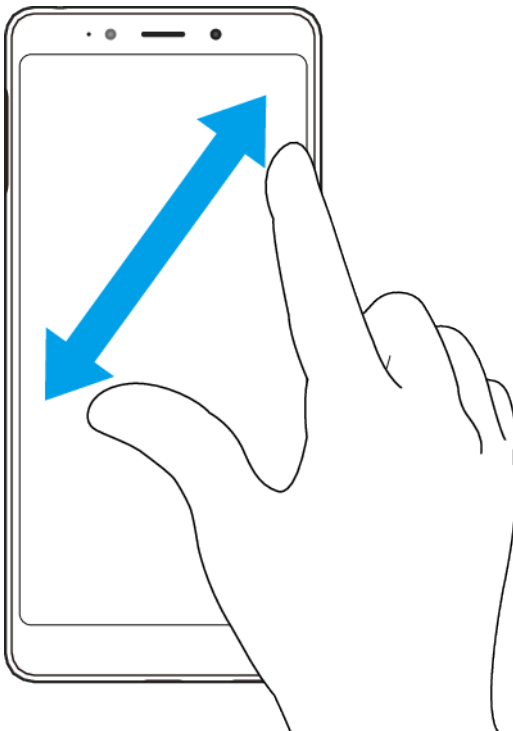

- Pinch in and out on web pages, photos and maps, and when you're taking photos or shooting videos.

## Swiping and scrolling

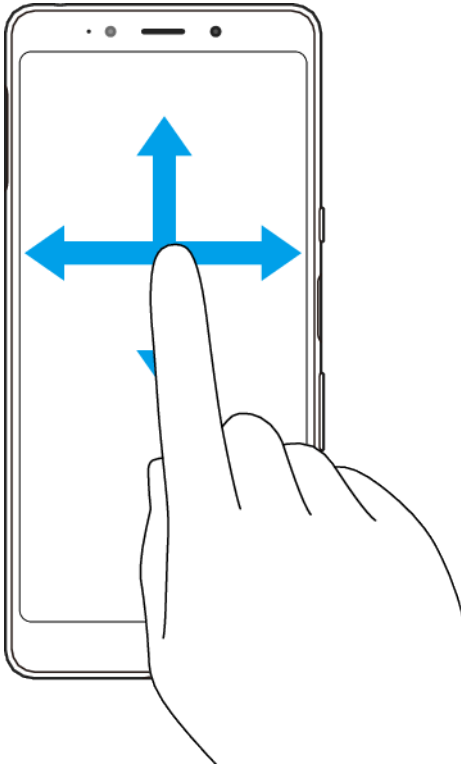

- Scroll up and down, or left and right.
- Swipe left or right, for example, between Home screen panes.

## Turning the screen on or off

When your device is on and left idle for a set period of time, the screen dims and turns off to save battery power. You can change how long your screen stays active before it turns off.

When your screen is turned off, your device can be locked or unlocked, depending on your screen lock setting. See *Screen lock* on page 11.

### To turn the screen on or off

- Briefly press the power key.

### To adjust the idle time before the screen turns off

- 1 Find and tap **Settings** > **Display** > **Sleep**.
- 2 Select an option.

## Home screen

The Home screen is the starting point for using your device. It's similar to the desktop on a computer screen. The number of Home screen panes is represented by a series of dots at the lower part of the Home screen. The highlighted dot shows the pane that is currently displayed.

### To go to the Home screen

- Tap  (Home button).

## To browse the Home screen



## Home screen panes

You can add new panes to your Home screen and delete panes. You can also set the pane that you want to use as the main Home screen pane.

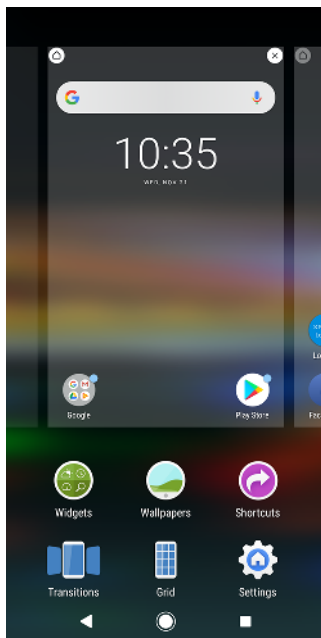

### Note

When Google Feed is enabled, the left most pane is reserved for this service. The main Home screen pane cannot be changed, and additional panes cannot be added to the left.

### To set a pane as the main Home screen pane

- 1 Touch and hold an empty area on your Home screen until the device vibrates.
- 2 Swipe left or right to browse to the pane that you want to set as your main Home screen pane, then tap  (Set pane icon).

### To add a pane to your Home screen

- 1 Touch and hold an empty area on your Home screen until the device vibrates.
- 2 Swipe the panes all the way to the right or left, then tap  (Add pane icon).

### To delete a pane from your Home screen

- 1 Touch and hold an empty area on your Home screen until the device vibrates.
- 2 Swipe left or right to browse to the pane that you want to delete, then tap  (Delete pane icon) on the top-right corner of the pane.

## Home screen settings

You can use the Settings shortcut to adjust some basic Home screen settings. For example, you can adjust the size of icons on your Home screen.

### To adjust the grid size of the screen

- 1 Touch and hold an empty area on your Home screen until the device vibrates.
- 2 Tap **Grid**, then select a size.
- 3 Tap **APPLY**.

### To adjust the size of icons on your Home screen

- 1 Touch and hold an empty area on your Home screen until the device vibrates, then tap  (Home screen settings icon).
- 2 Tap **Icon size**, then select an option.

## Application screen

The Application screen, which you open from the Home screen, contains the applications that come pre-installed on your device as well as applications that you download.

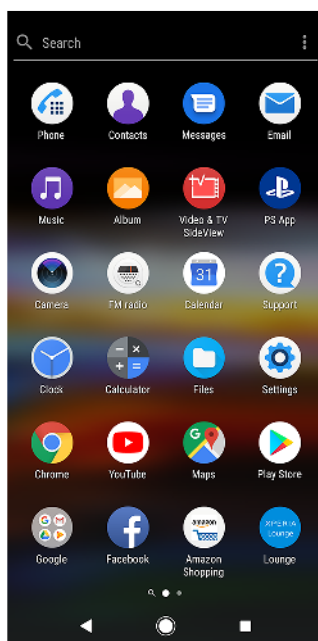

### To view all applications on the Application screen

- 1 Tap  (App tray icon).
- 2 Swipe left or right on the Application screen.

#### Hint

You can also search for recently viewed apps by swiping left from the Application screen.

### To enable or disable the recommended apps listings

- 1 Touch and hold an empty area on your Home screen, then tap  (Home screen settings icon).
- 2 Tap the **App recommendations** switch.

### To open an application from the Application screen

- When the Application screen is open, swipe left or right to find the application, and then tap the application.

### To search for an application from the Application screen

- 1 When the Application screen is open, tap **Search**.
- 2 Enter the name of the application that you want to search for.

#### Hint

You can also search for applications by swiping right from the Application screen.

### To arrange applications on the Application screen

- 1 When the Application screen is open, tap  (Menu icon).
- 2 Tap **Sort apps**, then select an option.

### To add an application shortcut to the Home screen

- 1 On the Application screen, touch and hold an application icon until the device vibrates, then drag the icon to the top of the screen. The Home screen opens.
- 2 Drag the icon to the desired location on the Home screen, then release it.

### To move an application on the Application screen

- 1 When the Application screen is open, tap  (Menu icon).
- 2 Make sure that **Own order** is selected under **Sort apps**.
- 3 Touch and hold the application until the device vibrates, then drag it to the new location.

## Navigating applications

You can navigate between applications using the navigation buttons and the recently used applications window, which lets you switch easily between all recently used applications. The navigation buttons are the back button, the home button, and the recent apps button. You can also pop open two applications on the screen at once using the Split screen mode, if the application supports multi-window function.

## Navigating applications overview

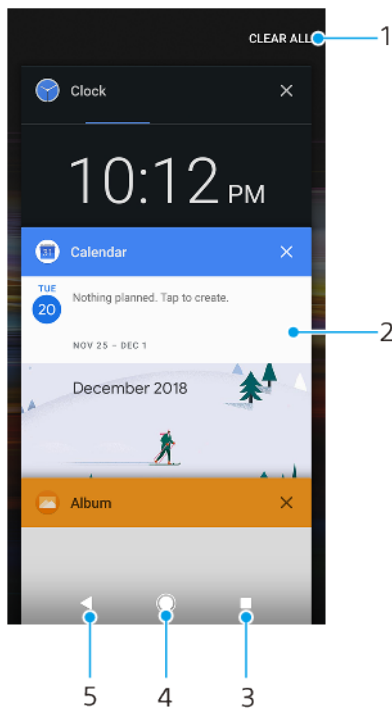

- 1 Clear all – Close all the recently used applications
- 2 Recently used applications window – Open a recently used application
- 3 Recent apps button – Open the recently used applications window
- 4 Home button – Exit an application and go back to the Home screen
- 5 Back button – Go back to the previous screen within an application or close the application

### To open the recently used applications window

- Tap  (Recent apps button).

### To quickly switch between recently used applications

- Quickly tap  (Recent apps button) twice.

### To close all the recently used applications

- Tap  (Recent apps button) and then tap **Clear all**.

### To open a menu in an application

- While using an application, tap  (Menu icon) or  (Options icon).

#### Note

A menu is not available in all applications.

## Split screen mode

Split screen mode enables you to view two applications at once, for example, if you want to view your email inbox and a web browser at the same time.

## Split screen overview





- 1 Application 1
- 2 Split screen border – Drag to resize windows
- 3 Application 2
- 4 Split screen button – Select a recently used application
- 5 Home button – Go back to the Home screen
- 6 Back button – Go back to the previous screen within an application or close the application

### Note

Not all applications support Split screen mode.

### To use Split screen mode

- 1 Make sure that the two applications that you want to use in Split screen mode are open and running in the background.
- 2 Open the application that you would like to use in Split screen mode, then touch and hold  (Recent apps button). The application will be assigned to the first part of the split screen.
- 3 Select the second desired application from the thumbnail list. If you want to resize the split screen windows, drag the split screen border in the centre.
- 4 To exit Split screen mode, touch and hold  (Split screen button) while the split screen windows are displayed.

## Widgets

Widgets are small applications that you can use directly on your Home screen. They also function as shortcuts. For example, the calendar widget allows you to see your schedule directly on the Home screen. When you tap the widget, the full Weather application opens. You can download additional widgets on Google Play.

### To add a widget to the Home screen

- 1 Touch and hold an empty area on your Home screen until the device vibrates, then tap **Widgets**.
- 2 Find and tap the widget that you want to add.

### To resize a widget

- 1 Touch and hold a widget until the device vibrates, then release it.
- 2 If the widget can be resized, the **Resize** option appears. For example, the Calendar widget is one that can be resized.
- 3 Tap **Resize** and drag the dots to shrink or expand the widget.
- 4 To confirm the new size, tap anywhere on the Home screen.

### To move a widget

- Touch and hold the widget until the device vibrates, then drag it to the new location.

### To remove a widget

- Touch and hold the widget until the device vibrates, then drag it to **Remove from home screen**.

## Shortcuts and folders

Use shortcuts and folders to manage your applications and keep your Home screen tidy.

### Shortcuts and folders overview

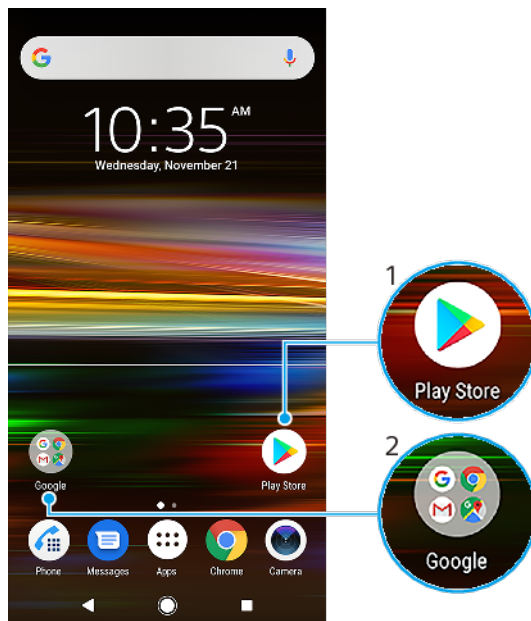

- 1 Access an application using a shortcut
- 2 Access a folder containing applications

### To add an application shortcut to your Home screen

- 1 Touch and hold an empty area on your Home screen until the device vibrates.
- 2 In the customisation menu, tap **Shortcuts**.
- 3 Scroll through the list and select an application. The selected application gets added to the Home screen.



### To move an item on the Home screen

- Touch and hold the item until the device vibrates, then drag the item to the new location.

### To remove an item from the Home screen

- Touch and hold the item until the device vibrates, then drag the item to **Remove from home screen**.

### To create a folder on the Home screen

- Touch and hold an application icon or a shortcut until the device vibrates, then drag and drop it on top of another application icon or shortcut.

### To add items to a folder on the Home screen

- Touch and hold an item until the device vibrates, then drag the item to the folder.

### To rename a folder on the Home screen

- 1 Tap the folder to open it.
- 2 Tap the folder's title bar to show a text entry field.
- 3 Enter the new folder name and tap **DONE**.

#### Hint

You can also use a shortcut for easy action. Touch and hold the folder name and tap **Rename**.

## Background

Your device comes with a default background, but you can adapt the Home screen and Lock screen to your own style using wallpapers featuring different colours and patterns.

A wallpaper may be used without changing any of the other elements of your Home screen and Lock screen. Live wallpapers add visual effects to your interactions with the touchscreen, letting the display change dynamically.

### To change your wallpaper

- 1 Touch and hold an empty area on your Home screen until the device vibrates.
- 2 Tap **Wallpapers**.
- 3 To set the same wallpaper for the Lock and Home screens, select the wallpaper and tap **APPLY**. To set different wallpapers, first tap the Lock or Home screen preview. Choose a wallpaper for that screen and tap **SELECT > APPLY**.
- 4 Select an option.

#### Hint

You can also use a photo as your wallpaper. Instead of selecting a wallpaper from the options shown, tap **Photos**. Choose a photo and tap **SELECT > APPLY**.

## Taking a screenshot

You can capture still images of any screen on your device as a screenshot. Screenshots you take are automatically saved in the Album application.

### To take a screenshot

- 1 Long press the power key until the options menu opens.
- 2 Tap **Screenshot**.

**Hint**

You can also take a screenshot by pressing and holding the power key and volume down key at the same time.

**To view your screenshot**

- 1 Double-tap the status bar to display the Notification panel.
- 2 Tap the screenshot.

## Notifications

Notifications inform you of events such as new messages and calendar notifications as well as activities in progress such as file downloads. Notifications appear in the following places:

- The status bar
- The notification panel
- The lock screen
- The app icon

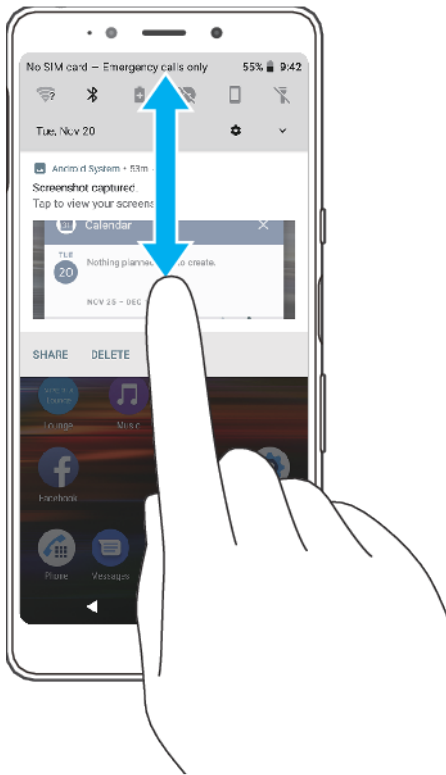
**To open or close the Notification panel**

- 1 To open the Notification panel, drag the status bar downwards, or simply double-tap it.
- 2 To close the Notification panel, drag or swipe the panel upwards.

**Hint**

After opening the Notification panel, you can access the Quick settings panel by dragging the status bar down again.

**To take action on a notification in the Notification panel**

- Tap the notification.

### To dismiss a notification from the Notification panel

- Swipe the notification left or right.

#### Note

Not all notifications can be dismissed.

#### Hint

To snooze a notification, drag the notification slowly to the side and tap ⌚ (Snooze icon). Notifications can be snoozed for 15, 30 minutes or 1 or 2 hours.

### To expand a notification on the Notification panel

- Tap ▾ (More options icon) to expand and view more information about the notification without opening the app.

### To clear all notifications from the Notification panel

- Tap **Clear all**.

#### Hint

If there is a long list of notifications, scroll down to find the Clear all button.

### To take action on a notification from the lock screen

- Double-tap the notification.

### To dismiss a notification from the lock screen

- Swipe the notification left or right.

### To expand a notification on the lock screen

- Drag the notification downwards.

## Notification display options on the lock screen

### Don't show notifications at all

You won't get any notifications on the lock screen.

### Show all notification content

Get all notifications on the lock screen. When you have this setting turned on, keep in mind that all content (including the content of incoming emails and chat messages) will be visible on your lock screen unless you designate the relevant applications as **Hide sensitive notification content** in the **Configure notifications** settings menu.

### Hide sensitive notification content

You must have a PIN, password, or pattern set up as your screen lock in order for this setting to be available. **Contents hidden** is displayed on the lock screen when sensitive notifications arrive. For example, you'll get a notification for an incoming email or chat, but the content won't be visible on your lock screen.

### To select the notifications to display on the lock screen

- 1 Find and tap **Settings > Apps & notifications > Configure notifications**.
- 2 Tap **Show notifications**.
- 3 Select an option.

## Setting the notification level for an app

You can set how to receive notifications from an application.

### To set the notification level for an app

- 1 Find and tap **Settings > Apps & notifications**.
- 2 Select the desired app, then tap **App notifications**.
- 3 Tap the switches to adjust notification settings as desired.

## Notification light

The notification light informs you about battery status and some other events. For example, a flashing light means there is a new message or a missed call. The notification light is enabled by default but can be disabled manually.



### Note



















When the notification light is disabled, it only lights up when there is a battery status warning, for example, when the battery level goes below 15 percent.

### To enable or disable the notification light

- 1 Find and tap **Settings > Apps & notifications > Configure notifications**.
- 2 Tap the **Blink light** switch to enable or disable the function.

## Icons in the status bar

### Status icons





















	No SIM card
	Signal strength
	The mobile network mode is also displayed when sending and downloading mobile data.
	No signal
	Roaming
	Mobile data is disabled
	A Wi-Fi connection is enabled and data is being transmitted
	A Wi-Fi connection is enabled but there is no internet connection.
	This icon also appears when you are trying to connect to a secured Wi-Fi or captive portal network. After a successful login, the cross mark disappears.
	If Google is blocked in your area, the cross mark may appear even when the device is connected to a network and there is a Wi-Fi working internet connection.
	Battery status
	The estimated remaining battery percentage is also displayed.
	The battery is charging
	The estimated remaining battery percentage is also displayed.
	Airplane mode is activated
	The Bluetooth function is activated
	The microphone is muted
	The speakerphone is on
	Do not disturb mode is activated
	Vibrate mode
	An alarm is set
	GPS is activated
	Synchronisation is ongoing

 Problem with sign-in or synchronisation

**Note**

Depending on your service provider, network, or region, the functions or services represented by some icons in this list may not be available.

## Notification icons

	New text message or multimedia message
	Ongoing call
	Missed call
	Call on hold
	Call forwarding is turned on
	New voicemail message
	New email message
	Downloading data
	Uploading data
	Mobile data is disabled
	System updates are available
	Downloading system updates
	Install the downloaded system updates
	An application update is available
	Screenshot captured
	Video chat with friends using Duo application
	A song is playing
	The device is connected to a computer via a USB cable
	Warning
	More undisplayed notifications

**Note**

Not all icons that may appear on your device are listed here. This list is for reference purposes only, and changes may be made without notice.

### To block an application from sending notifications

- 1 Find and tap **Settings > Apps & notifications**.
- 2 Select the desired application, then tap **App notifications**.
- 3 Tap the **On** switch to block application notifications.

# Battery and maintenance

## Charging your device

Always use an original Sony charger and USB Type-C™ cable intended for your specific Xperia model. Other chargers and cables may increase charging time, not charge at all, or may even damage your device. Make sure all USB ports and connectors are completely dry before inserting the cable.

If the battery is depleted, it may take up to 30 minutes for your device to respond to the charging. During this time, the screen may remain completely dark, not showing the charging icon. It can take up to 4 hours for a completely drained battery to be fully charged. Charging speed may be affected by ambient temperature.

### Note

Your device has an embedded, rechargeable battery that can only be replaced by an authorised Sony repair centre. Never try to open or take apart the device yourself. Doing so can cause damage and void your warranty.

### Hint

A wall socket charger will charge your device faster than charging via computer. You can still use your device while charging.

## To charge your device

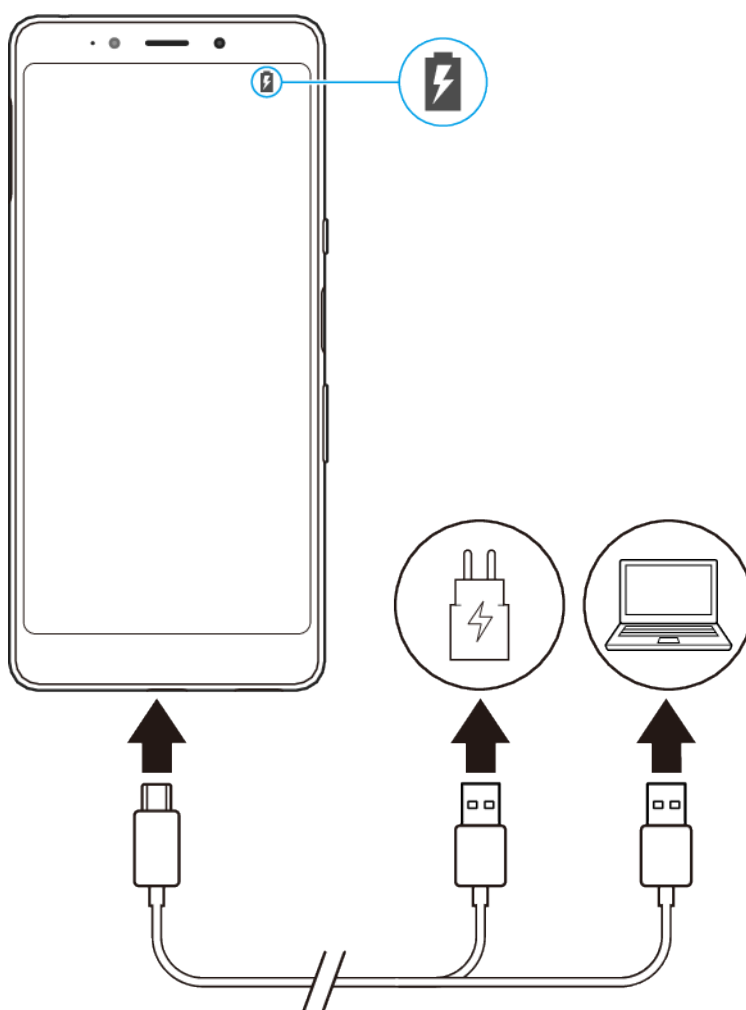

- 1 Connect one end of the USB cable to the charger (or to the USB port of a computer).
- 2 Connect the other end of the cable to the USB port on your device. The notification light illuminates when charging begins.
- 3 When the device is fully charged, disconnect the cable from your device by pulling it straight outwards. Make sure not to bend the connector.

**Note**

It is important to use a USB Type-C cable (provided), as other types of USB cables can damage your device.

**Hint**

If the battery is completely depleted, it may take a few minutes before the notification light illuminates and the charging icon appears.

## Battery notification light status

Green	Battery is charging, charge level is greater than 90%
Yellow	Battery is charging, charge level is 15–90%
Red	Battery is charging, charge level is less than 15%

## Battery and power management

Your device has an embedded battery. To get the most use from it, keep track of the power consumed by different applications and features.

### To review your battery consumption

- Find and tap **Settings** > **Battery** to view the estimated remaining battery percentage and battery time.

### To view battery consumption for applications

- 1 Find and tap **Settings** > **Apps & notifications**.
- 2 Select an application and review its battery consumption under **Battery**.

## General usage tips to improve battery performance

The following tips can help you improve battery performance:

- Lower the screen brightness level, see *Screen settings* on page 48.
- Turn off Bluetooth, Wi-Fi and location services when you don't need these features.
- Turn off your device or use Airplane mode if you are in an area with no or low network coverage. Otherwise, your device repeatedly scans for available networks, and this consumes power.
- Use a Wi-Fi network instead of roaming when abroad. Roaming is scanning for your home network and puts additional demands on your battery as your device must transmit with a higher output power, see *Wi-Fi* on page 40.
- Change the synchronisation settings for your email, calendar and contacts.
- Check the applications that have a high battery consumption and consider the battery saving tips provided on your device for these applications.
- Change the notification level for an application, see *Notifications* on page 26.
- Turn off the location-sharing permission for an application, see *Application settings* on page 50.
- Uninstall applications that you are not using, see *Application screen* on page 20.
- Use a Sony original handsfree device to listen to music. Handsfree devices consume less battery than your device's loudspeakers.
- Restart your device every now and then.

## Updating your device

You should update the software on your device to get the latest functionality, enhancements, and bug fixes in order to ensure optimal performance. When a software update is available,  (System update icon) appears in the status bar. You can also check for new updates manually, or schedule an update.

The easiest way to install a software update is to do it wirelessly from your device. However, some updates are not available for wireless download. You then need to use the Xperia Companion software on a PC or on an Apple Mac® computer to update your device.

Before updating your device, consider the following:

- Ensure you have sufficient storage capacity.
- System and application updates can present the features on your device in another way than described in this User guide. The Android version might not be affected after an update.

### To check for new software

- 1 If you are using a device with multiple users, make sure you are logged in as the owner.
- 2 Find and tap **Settings > System > Software update**.

## Updating your device wirelessly

Use the Software update application to update your device software wirelessly. The updates you can download over a mobile network depend on your operator. It is recommended to use a Wi-Fi network instead of a mobile network to download new software so that you can avoid data traffic costs.

### To install a system update

- 1 If you are using a device with multiple users, make sure you are logged in as the owner.
- 2 Find and tap **Settings > System > Software update**.
- 3 If a system update is available, tap **UPDATE**.
- 4 Restore the device when prompted.

### To set up automatic download of system updates

- 1 Find and tap **Settings > System > Software update**.
- 2 Tap  (Menu icon), then tap **Settings > Auto update system**.
- 3 Select the preferred option.

### To enable or disable automatic updates for applications

- 1 Find and tap **Settings > System > Software update**.
- 2 Tap  (Menu icon), then tap **Settings > Auto-update apps**.
- 3 Select the preferred option.

### To update your device using a computer

- 1 Connect your device to the computer using a USB cable.
- 2 Make sure that the screen of your device is unlocked, and that the USB connection mode on the device is set to Transfer files.
- 3 Open Xperia Companion, if it is not automatically launched.
- 4 Make sure that the computer can access the internet.



- 5 **Computer:** If a new software update is detected, a pop-up window appears. Follow the on-screen instructions to run the relevant software updates.

**Note**

If you don't have the Xperia Companion software installed on the relevant computer, connect your device to the computer and follow the on-screen installation instructions. Make sure that you are using the USB Type-C cable that came with your device and that it is properly connected to the device and computer.

## Restarting, resetting and repairing

You can force your device to restart or shut down if it stops responding or won't restart normally. No settings or personal data get deleted.

You can also reset your device to its original factory settings. This action is sometimes necessary if your device stops functioning properly, but note that if you want to keep any important data, you should first back up this data to a memory card or other non-internal memory. For more information, see *Backing up and synchronising with a Google account* on page 36.

If your device fails to turn on or you want to reset your device's software, you can use Xperia Companion to repair your device. For more information on using Xperia Companion, see Xperia Companion web site <https://support.sonymobile.com/xperia-companion/>.

### To restart your device

**Note**

Your device may fail to restart if the battery level is low. Connect your device to a charger and try restarting again.

- 1 Long press the power key.
- 2 In the menu that opens, tap **Restart**. The device restarts automatically.

### To force the device to restart or shut down

- 1 Long press the power key and the volume up key at the same time until your device vibrates.
- 2 Depending on whether you wish to force the device to restart or shut down, proceed as follows.
  - If you wish to force restart the device: Release the keys at this point. The device restarts.
  - If you wish to force shut down the device: Continue pressing the keys. After a few more seconds, the device vibrates three times and turns off.

### To perform a factory data reset

**Note**

To avoid permanent damage to your device, do not interrupt a factory data reset procedure.

- 1 Back up any important data that is saved on the internal memory of your device to a memory card or other non-internal memory. If you have any encrypted files stored on an SD card, you should also remove the encryption to ensure you can still access them after the reset.
- 2 Find and tap **Settings > System > reset**.
- 3 Tap **Factory data reset > Reset phone**.
- 4 If required, draw your screen unlock pattern or enter your screen unlock password or PIN to continue.
- 5 To confirm, tap **Erase everything**.

**Hint**

Your device does not revert to an earlier software version of Android when you perform a factory data reset.

## Repairing the device software

You can use Xperia Companion to repair your device's software. If you forget your screen unlock password, PIN or pattern, you can use the device repair feature in Xperia Companion to erase the security layer. You need to provide your Google account login details to perform this operation. By running the repair feature, you reinstall software for your device and you may lose some personal data in the process.

If your device seems to have frozen, restarts repeatedly or doesn't start at all after you've updated the Xperia software or after you've performed a software repair or a factory data reset, try forcing the device to shut down then try turning it back on. If the problem still exists, force the device to shut down then perform a software repair.

**Hint**

When you receive a new Google account username or password, you might not be able to use them to log in.

### To repair the device software using Xperia Companion

**Note**

Before performing a software repair, make sure you know your Google account username and password. Depending on your security settings, you may need to enter them in order to restart the device after a software repair.

- 1 Make sure that Xperia Companion is installed on the computer.
- 2 Open the Xperia Companion software on the computer and click **Software repair** on the main screen.
- 3 Follow the instructions that appear on the screen to reinstall the software and complete the repair.

## Improving memory performance

Your device has several different storage and memory options:

- The internal storage stores downloaded or transferred content along with personal settings and data.
- To get more free internal storage space, you can use a removable memory card or Google service to store your data.

**Note**

- You can purchase a memory card separately.
- The dynamic memory (RAM) cannot be used for storage. RAM is used to handle running applications and the operating system.

Your device memory tends to fill up as a result of normal usage. If the device starts to slow down, or applications suddenly shut down, you should consider the following:

- Close running applications that you are not using.
- Clear the cache memory for all applications.
- Uninstall downloaded applications that you don't use.
- Transfer photos, videos, and music from the internal memory to the memory card.
- If your device can't read content on the memory card, you may need to format the card. Note that when you format the card, all content is erased.

### To view the memory status

- Find and tap **Settings > Storage**.

### To clear the cache memory for all applications

- 1 Find and tap **Settings > Storage**.
- 2 Tap **FREE UP SPACE**. If you have a memory card inserted, select **Storage > Internal shared storage > FREE UP SPACE**.

#### Hint

When you clear the cache memory, you don't lose any important information or settings.

### To stop applications and services from running

- 1 Find and tap **Settings > Apps & notifications**.
- 2 Select an application or service, then tap **FORCE STOP > OK**.

### To format the memory card

- 1 Find and tap **Settings > Storage**.
- 2 Tap **SD card > ⋮ (Menu icon)**, then tap **Storage settings > Format > Erase & format**.

#### Note

All content on the memory card gets erased when you format it. Make sure you first make backups of all data that you want to save. To back up your content, you can copy it to a computer. For more information, see *Backing up and transferring data using a computer* on page 37.

# Backing up and synchronising data

## Backing up and synchronising with a Google account

You can back up your data to the Google server and synchronise with a Google account. Depending on the types of content, there are several ways to back up and synchronise. If you want to transfer data from your old device to a new device, set the backup on your old device, and synchronise with your Google account on the new device. Backing up is especially recommended if you are updating your device software to a newer Android version.

### To set up a Google account

- 1 Tap **Settings** > **Users & accounts** > **Add account**, then select **Google**.
- 2 Follow the on-screen instructions to create or sign in to an account.



### To back up and synchronise Gmail, Calendar, and Contacts

- 1 Tap **Settings** > **Users & accounts**.
- 2 If there is no Google account yet, tap **Add account**.
- 3 Tap the **Automatically sync data** switch to enable the function. Your Gmail, Calendar, and Contacts will be backed up automatically.

#### Note

You can transfer and synchronise Gmail, Calendar, and Contacts data automatically by logging in to the Google account used to synchronise data on your old device.

### To back up and synchronise photos and videos

- 1 Find and tap  (Google Photos icon).
- 2 Tap  (Options icon), and then tap the settings menu.
- 3 Tap the backup and sync menu.
- 4 Tap the switch to enable the function. Your photos and videos will be backed up automatically.

#### Note

You can synchronise photos and videos automatically by logging in to the Google account used to synchronise data on your old device. For more information about Google Photos, go to <http://support.google.com>.



### To back up and synchronise apps, phone settings, and call history

- 1 Find and tap **Settings** > **System** > **Back up**.
- 2 Tap the switch to enable the function. Your app data, device settings, and call history will be backed up automatically.

#### Note

You can also enable backup from the settings menu in Google Drive. You can synchronise your app data, device settings, and call history automatically by logging in to the Google account used to synchronise data on your old device. When you power on your new device for the first time, log in to the Google account and follow the on-screen instructions.

### To back up and synchronise files manually

- 1 Find and tap  (Music icon) or  (Files icon).
- 2 Touch and hold the files you want to back up and select **Share** from the options that appear.
- 3 Save to Google Drive.

#### Note

You can synchronise data on your new device by logging in to the Google account used to synchronise data on your old device.

## Backing up and transferring data using a computer

It is recommended to back up your data to a computer when you have large volumes of media files, such as photos, videos, music files. You can also transfer your data from an old device to your new device, by connecting both devices to the computer at the same time. Use a USB cable connection between a Windows computer and your device to transfer and manage your files.

### To connect to a computer using a USB cable

- 1 Connect your device to the computer using a USB cable.
- 2 Drag down the status bar, and then tap **USB charging this device**.
- 3 Your computer will detect your device once you tap **Transfer files**.

#### Note

Always use a USB Type-C cable intended for your specific Xperia model and make sure it is completely dry.

### To back up your data using a computer

- 1 Unlock the screen of your device and connect your device to the computer using a USB cable.
- 2 On the computer, select which files to back up, then copy and paste or drag and drop the files to a location on your computer.

### To transfer files from your old device to new device



- 1 Unlock the screen of your device and connect both your old device and new device to a computer using a USB cable.
- 2 On the computer, select which files to transfer from your old device, then copy and paste or drag and drop the files to a location on your new device.

#### Note

When you copy files from your old device to the new device, make sure that the folder names are the same on both devices.

## Backing up and transferring data using a memory card

### To back up and transfer files using a memory card

- 1 Make sure you have a memory card inserted into your device.
- 2 Find and tap  (Files icon).
- 3 Tap and hold and mark the files that you want to transfer to the memory card.
- 4 Tap  (Menu icon) and select **Copy to...** or **Move to...** to back up or transfer.

## Synchronising with Microsoft Exchange ActiveSync

If your company uses a Microsoft Exchange ActiveSync account, you can access your corporate email messages, calendar appointments, and contacts directly on your device. After setup, you can find your information in the Email, Calendar, and Contacts applications.

#### Hint

If you have set up a Microsoft Exchange ActiveSync (EAS) account on your device, the EAS security settings may limit the lock screen type to only a PIN or password. This occurs when your network administrator specifies a lock screen type for all EAS accounts for enterprise security reasons. Contact the network administrator of your company or organisation to check what network security policies are implemented for mobile devices.

### To set up an EAS account for synchronisation

- 1 Tap **Settings > Users & accounts > Add account > Exchange ActiveSync**.

- 2 Enter your corporate email address and password.
- 3 Tap **Next**. If a failure occurs, enter the domain and server details for your account manually and then tap **Next**.
- 4 Follow the on-screen instructions to complete the setup.
- 5 Tap **Show more sync options** to select a synchronisation method, a synchronisation interval, and the data that you want to synchronise with your device.
- 6 Tap **Next**, then select how you want to be notified when a new email arrives.
- 7 Tap **Next**, enter a name for the corporate account, then tap **Finish setup**.
- 8 If prompted, activate the device administrator to allow your corporate server to set certain security rules on your device, such as disabling voice recording and using storage encryption.

#### To remove an EAS account

- 1 Find and tap **Settings > Users & accounts**.
- 2 Select the EAS account that you want to remove.
- 3 Tap **Remove account**.
- 4 Tap **Remove account** again to confirm.

# Downloading applications

## Downloading applications on Google Play

Google Play is the official online Google store for downloading applications, games, music, movies, and books. It includes both free and paid applications. Before you start downloading on Google Play, make sure that you have a working internet connection, preferably over Wi-Fi to limit data traffic charges. For more information, see *Updating your device* on page 32.

### To download an application on Google Play

- 1 Find and tap ► (Play Store icon).
- 2 Find an item you wish to download by browsing categories, or by using the search function.
- 3 Tap the item to view its details. Follow the on-screen instructions to complete the installation.

## Downloading applications from other sources

When your device is set to allow downloads from sources other than Google Play, you can download applications directly from other websites by following the relevant download instructions.

### Note

Installing applications of unknown or unreliable origin can damage your device. Download applications only from reliable sources. Contact the application provider if you have any questions or concerns.

### To enable or disable the downloading of applications from other sources

- 1 Find and tap **Settings > Apps & notifications**.
- 2 Tap **Advanced > Special app access > Install unknown apps**.
- 3 Tap the application you want to allow the installing of application from other sources, then tap the **Allow from this source** switch to enable or disable.

# Internet and networks

## Internet and MMS settings

To access the internet, or send multimedia messages without Wi-Fi, you need a mobile data connection with correct internet and MMS settings. Here are some tips:

- For most mobile networks and operators, these settings come pre-installed on your device so you can start using the internet and sending multimedia messages right away.
- You can manually check for updates to the internet and MMS settings. If you change or delete an internet or MMS setting by mistake, reset the internet and MMS settings.

### To download internet and MMS settings

- 1 Find and tap **Settings > Network & Internet > Internet settings**.
- 2 Tap **Accept**. Once the settings have been downloaded successfully,  (Internet settings downloaded icon) appears in the status bar and mobile data traffic is turned on automatically.

#### Hint

If the settings cannot be downloaded to your device, check the signal strength of your mobile or Wi-Fi network connections. Move to an open location free from obstructions or get close to a window and then try again.

### To add internet and MMS settings

- 1 Find and tap **Settings > Network & Internet > Mobile network**.
- 2 Dual SIM users, select a SIM card.
- 3 Tap **Access point names > +** (Add icon).
- 4 Tap **Name** and enter a name of your choice, then tap **OK**.
- 5 Tap **APN** and enter the access point name, then tap **OK**.
- 6 Enter all other required information. If you don't know what information is required, contact your network operator for more details.
- 7 When you're done, tap , then tap **Save**.

### To view downloaded internet and MMS settings

- 1 Find and tap **Settings > Network & Internet > Mobile network**.
- 2 Dual SIM users, select a SIM card.
- 3 Tap **Access point names**.
- 4 To view more details, tap any of the available items.

### To reset the internet and MMS settings

- 1 Find and tap **Settings > Network & Internet > Mobile network > Access point names**.
- 2 Tap .
- 3 Select **Reset to default**.

## Wi-Fi

Use Wi-Fi to surf the internet, download applications, or send and receive emails. Once you have connected to a Wi-Fi network, your device remembers the network and automatically connects to it the next time you come within range.

Available Wi-Fi networks may be open or secured. Secured networks are indicated by  (Wi-Fi lock icon) next to the Wi-Fi network name.



**Note**

Some Wi-Fi networks do not show up in the list of available networks because they do not broadcast their network name (SSID). If you know the network name, you can add it manually to your list of available Wi-Fi networks.

**To turn Wi-Fi on or off**

- 1 Find and tap **Settings > Network & Internet > Wi-Fi**.
- 2 Tap the switch to enable or disable Wi-Fi.

**To connect to a Wi-Fi network**

- 1 Find and tap **Settings > Network & Internet > Wi-Fi**.
- 2 Tap the switch to turn on Wi-Fi. All available Wi-Fi networks are displayed.
- 3 Tap a Wi-Fi network to connect to it. For secured networks, enter the relevant password.  (Wi-Fi icon) is displayed in the status bar once you are connected.

**To add a Wi-Fi network manually**

- 1 Find and tap **Settings > Network & Internet > Wi-Fi**.
- 2 Scroll down and tap **Add network**.
- 3 Enter the **Network name** information.
- 4 To select a security type, tap the **Security** field.
- 5 If required, enter a password.
- 6 To edit advanced options such as proxy and IP settings, tap **Advanced options** and then edit the options as desired.
- 7 Tap **SAVE**.

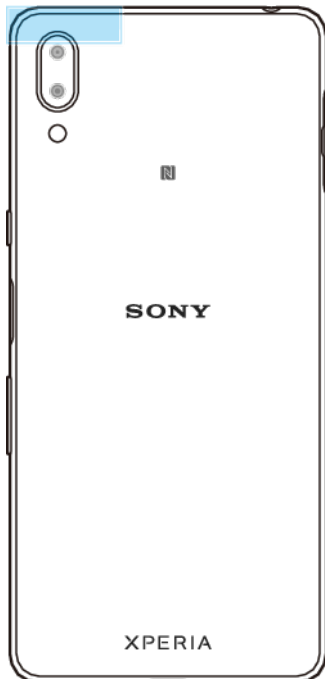
**Increasing Wi-Fi signal strength**

There are a number of things you can do to improve Wi-Fi reception:

- Move your device closer to the Wi-Fi access point.
- Move the Wi-Fi access point away from any potential obstructions or interference.
- Don't cover the Wi-Fi antenna area of your device.

## Wi-Fi settings

When you are connected to a Wi-Fi network or when there are Wi-Fi networks available in your vicinity, you can view the status of these networks. You can also enable your device to notify you whenever an open Wi-Fi network is detected.

### To enable or disable Wi-Fi network notifications

- 1 Make sure that Wi-Fi is turned on for your device.
- 2 Find and tap **Settings > Network & Internet > Wi-Fi**.
- 3 Scroll down and tap **Wi-Fi preferences**.
- 4 Tap the **Open network notification** switch to enable or disable.

### To view detailed information about a connected Wi-Fi network

- 1 Find and tap **Settings > Network & Internet > Wi-Fi**.
- 2 Tap the Wi-Fi network that you are currently connected to. Detailed network information is displayed.

### To find the MAC address for your device

- 1 Find and tap **Settings > Network & Internet > Wi-Fi**.
- 2 Tap **Wi-Fi preferences > Advanced**.  
The MAC address is displayed in the list.

#### Hint

The Wi-Fi Mac address is also displayed under Settings > System > About phone > Status > Wi-Fi MAC address.

## Wi-Fi Protected Setup™

Wi-Fi Protected Setup is a wireless networking standard that helps you establish secure wireless network connections. Wi-Fi Protected Setup makes it easy for you to set up WPA™ (Wi-Fi Protected Access®) encryption to secure your network. You can also add new devices to an existing network without entering long passwords.

Use one of these methods to enable Wi-Fi Protected Setup:

- Push button method – simply push a button on a Wi-Fi Protected Setup-supported device, for example, a router.
- PIN method – your device creates a random PIN, which you enter on the Wi-Fi Protected Setup-supported device.

### To connect to a Wi-Fi network using a Wi-Fi Protected Setup button

- 1 Find and tap **Settings > Network & Internet > Wi-Fi**.
- 2 Turn on Wi-Fi if it is not already on.
- 3 Tap **Wi-Fi preferences > Advanced > WPS Push Button**, then tap the Wi-Fi Protected Setup button on the Wi-Fi Protected Setup-supported device.

### To connect to a Wi-Fi network using a Wi-Fi Protected Setup PIN

- 1 Find and tap **Settings > Network & Internet > Wi-Fi**.
- 2 Turn on Wi-Fi if it is not already on.
- 3 Tap **Wi-Fi preferences > Advanced > WPS PIN Entry**.
- 4 On the Wi-Fi Protected Setup-supported device, enter the PIN that appears on your device.

## Sharing your mobile data connection

You can share your mobile data connection with other devices in several ways.

- **USB tethering:** share your mobile data connection with a single computer using a USB cable.
- **Wi-Fi hotspot:** share your mobile data connection with up to 10 other devices simultaneously, including devices that support Wi-Fi Protected Setup technology.
- **Bluetooth tethering:** share your mobile data connection with up to four other devices via Bluetooth.



#### To share your data connection using a USB cable

- 1 Connect your device to a computer using the USB cable.
- 2 Find and tap **Settings > Network & Internet > Hotspot & tethering**.
- 3 Tap the **USB tethering** switch, then tap **OK** if prompted.  (USB sharing icon) is displayed in the status bar once you are connected.
- 4 To stop sharing your data connection, tap the **USB tethering** switch or disconnect the USB cable.

#### Note

You cannot share your device's data connection and SD card over a USB cable at the same time.



#### To share your mobile data connection with another Bluetooth device

- 1 Make sure that your device and the other Bluetooth device are paired with each other and that mobile data traffic is activated on your device.
- 2 **Your device:** Find and tap **Settings > Network & Internet > Hotspot & tethering**. Tap the **Bluetooth tethering** switch to enable the function.
- 3 **Bluetooth device:** Set up the device so that it obtains its network connection using Bluetooth. If the device is a computer, refer to the relevant instructions to complete the setup. If the device runs on the Android operating system, tap the settings icon beside the name of the device that it is paired with under **Settings > Device connection > Bluetooth > Paired devices**, then tap the **Internet access** switch.
- 4 **Your device:** Wait for  (Bluetooth tethering icon) and  (Bluetooth tethering icon) to appear in the status bar. Once these icons appear, the setup is complete.
- 5 Tap the **Bluetooth tethering** switch again to disable the function.

#### Note

The Bluetooth tethering function is turned off every time you turn off your device or turn off the Bluetooth function.

#### To use your device as a portable Wi-Fi hotspot

- 1 Find and tap **Settings > Network & Internet > Hotspot & tethering**.
- 2 Tap **Portable hotspot settings > Configure hotspot**.
- 3 Enter the **Network name** information.
- 4 To select a security type, tap the **Security** field. If required, enter a password.
- 5 Tap **Save**.
- 6 Tap  (Back button) and tap the **Wi-Fi hotspot** switch to enable the function.
- 7 If prompted, tap **OK** to confirm.  (Tethering icon) appears in the status bar when the portable Wi-Fi hotspot is active.
- 8 To stop sharing your data connection via Wi-Fi, tap the **Wi-Fi hotspot** switch to disable the function.

#### To rename or secure your Portable Hotspot

- 1 Find and tap **Settings > Network & Internet > Hotspot & tethering**.
- 2 Tap **Portable hotspot settings > Configure hotspot**.
- 3 Enter the **Network name** information.
- 4 To select a security type, tap the **Security** field. If required, enter a password.
- 5 Tap **Save**.

## Controlling data usage

You can keep track of the amount of data transferred to and from your device over your mobile data or Wi-Fi connection during a given period. For example, you can view the amount of data used by individual applications. For data transferred over your mobile data connection, you can also set data usage warnings and limits to avoid additional charges.

### To help reduce data usage

- 1 Find and tap **Settings** > **Network & Internet** > **Data usage** > **Data Saver**.
- 2 Tap the switch to enable or disable the function.

### To turn data traffic on or off

- 1 Find and tap **Settings** > **Network & Internet** > **Data usage**.
- 2 Tap the **Mobile data** switch to turn data traffic on or off.

#### Hint

When data traffic is turned off, your device can still establish Wi-Fi and Bluetooth connections.

### To set a data usage warning

- 1 Make sure that mobile data traffic is turned on.
- 2 Find and tap **Settings** > **Network & Internet** > **Data usage** > **Billing cycle**.
- 3 To set the warning level, tap the **Set data warning** switch.
- 4 Tap **Data warning**, enter the desired data limit and tap **Set**. You receive a warning notification when the amount of data traffic reaches the level you set.

### To set a mobile data limit

- 1 Make sure that mobile data traffic is turned on.
- 2 Find and tap **Settings** > **Network & Internet** > **Data usage** > **Billing cycle**.
- 3 Tap the **Set data limit** switch, then tap **OK**.
- 4 To set the data usage limit, tap **Data limit**, enter the desired data limit and tap **Set**.

#### Note

Once your mobile data usage reaches the set limit, mobile data traffic on your device gets turned off automatically.

### To control the data usage of individual applications

- 1 Find and tap **Settings** > **Apps & notifications**.
- 2 Tap the application that you want to control, then tap **Data usage**.

#### Hint

The performance of individual applications may be affected if you change the related data usage settings.

### To check your data usage

- 1 Find and tap **Settings** > **Network & Internet** > **Data usage**.
- 2 To view information about the amount of data transferred via mobile data connection, tap **Mobile data usage**.
- 3 To view information about the amount of data transferred via Wi-Fi connection, tap the **Wi-Fi data usage**.

## Selecting a SIM card for data traffic

#### Note

This function only applies for Dual SIM devices.

If you are using a Dual SIM device, you can select which SIM card handles data at any given time. You can do this during the initial setup of your device, or you can select or change it later via the Settings menu.

#### To change the SIM card used for data traffic

- 1 Find and tap **Settings > Network & Internet > Dual SIM > Mobile data.**
- 2 Select a SIM card.

## Selecting mobile networks

Your device automatically switches between mobile networks depending on which mobile networks are available where you are. You can also manually set your device to use a particular mobile network mode. If you are using a Dual SIM device, this applies to each SIM card.

Different status icons are displayed in the status bar depending on the type or mode of network that you are connected to. Refer to *Status icons* on page 28 to see what the different status icons look like.

#### To select a network mode

- 1 Find and tap **Settings > Network & Internet > Mobile network.**
- 2 Dual SIM users, select a SIM card.
- 3 Tap **Preferred network type**, then select a network mode.

##### Note

If you are using a Dual SIM device, LTE can only be selected for one SIM card.

#### To select another network manually

- 1 Find and tap **Settings > Network & Internet > Mobile network.**
- 2 Dual SIM users, select a SIM card.
- 3 Tap **Network operators > Search networks.**
- 4 Select a network.

##### Note

If you select a network manually, your device will not search for other networks, even if you move out of range of the manually selected network.

#### To activate automatic network selection

- 1 Find and tap **Settings > Network & Internet > Mobile network.**
- 2 Dual SIM users, select a SIM card.
- 3 Tap **Network operators > Automatic.**

# Basic settings

## Accessing settings

View and change settings for your device from the Settings menu. The Settings menu is accessible from both the Application screen and the Quick settings panel.

### To open the device settings menu from the Application screen

- Find and tap **Settings**.

### To view information about your device

- Find and tap **Settings > System > About phone**.

### To access the Quick settings panel

- Drag the status bar downwards using two fingers.

### To select which settings to display on the Quick settings panel

- 1 Using two fingers, drag the status bar fully downwards, then tap  (Edit icon).
- 2 To add a setting to the Quick settings panel, drag and drop the icon into the upper part of the screen. To remove a setting, drag and drop the icon into the lower part of the screen.

### To rearrange the Quick settings panel

- 1 Drag the status bar fully downwards, then tap  (Edit icon).
- 2 Touch and hold an icon, then move it to the desired position.

### To turn on the flashlight

- 1 Drag the status bar downwards using two fingers.
- 2 Tap  (Torch icon).



## Volume, vibration and sound



The volume and vibration can be changed either by using the volume keys or by changing a setting. Sounds and tones can only be changed from a setting.

### Note

App settings can override the selected volume, vibration and sound settings.

## Volume and vibration

You can use the volume key to quickly change the ring, media or alarm volumes. Additionally, you can set your device to vibrate  (Vibrate icon) or activate a Do not disturb option  (Silent icon) to mute sounds and vibrations. For more information about Do not disturb, see *Silence your device with Do not disturb* on page 47.

The ring volume  (Ringer volume icon) affects incoming calls and notifications, and the media volume  (Media volume icon) affects music, videos, games and other media. For example, if you change the volume while watching a video, the media volume is changed. The alarm volume is indicated with  (Alarm notification icon).

### To change the volume

- 1 Press the volume key up or down. This changes the ring and notification volume.
- 2 To change the media or alarm volumes, tap  (More options icon). Use each slider to adjust the volume.

**Hint**

Tap a volume icon to quickly turn the volume on or off.

**To activate vibration or Do not disturb mode**

- 1 Long press the volume key down until  (Vibrate icon) appears to activate vibrate mode.
- 2 Release the volume key and press it down again to activate **Do not disturb** mode.

**To activate sound with vibration for incoming calls**

- 1 Find and tap **Settings > Sound**.
- 2 Tap the **Also vibrate for calls** switch to enable the function.

## Sounds and tones

**To set the ringtone**

- 1 Find and tap **Settings > Sound > Phone ringtone**.
- 2 Dual SIM users, select a SIM card.
- 3 Select an option from the list or tap **Add ringtone** and select a music file that is saved on your device.
- 4 To confirm, tap **OK**.

**Hint**

To set a specific ringtone for a contact, see *Adding and editing contacts* on page 59. Dual SIM users can set different ringtones for each SIM card.

**To set the notification sound**

- 1 Find and tap **Settings > Sound > Advanced > Notification sound**.
- 2 Select a sound from the list or select **None** to turn off all notification sounds and set your notifications to vibrate only.
- 3 To select a music file that is saved on your device, tap **Add ringtone**.
- 4 To confirm, tap **OK**.

**Note**

You can change your app settings to allow a sound from a specific app even when the notification sound is set to None. See *Notifications* on page 26.



**To enable or disable other sounds and tones**

- 1 Find and tap **Settings > Sound > Advanced**.
- 2 Tap the switches to enable or disable the different sounds and tones.

## Silence your device with Do not disturb

Activate Do not disturb to mute sounds and limit vibrations and visual indications for situations in which you do not want to be disturbed, for example at night.

**To activate Do not disturb**

- 1 Drag the status bar downwards using two fingers to access the Quick settings panel.
- 2 Tap  (Do not disturb icon).
- 3 Tap  (More options icon) to set the limitation level.
- 4 Select the limitation level by tapping **Total silence**, **Alarms only** or **Priority only**.
- 5 Set how long you want **Do not disturb** to be activated and tap **DONE**.



**Hint**

Do not disturb can also be activated by pressing the volume key down when your device is in vibrate mode  (Vibrate icon).

### To deactivate Do not disturb

- 1 Press the volume key up.
- 2 If **Priority only** is set, tap **Turn off now**.

#### Hint

Do not disturb can also be deactivated by tapping  (Silent icon) or  (Total silence icon) from the Quick settings panel.

## Limitation levels

### **Total silence**

All vibrations and all ring, media and alarm sounds are turned off.

### **Alarms only**

The ring sound is turned off. Alarm and media sounds are still on.

### **Priority only**

You only receive the notifications and calls you have selected. Alarm and media sounds are still on.

### To set up Priority only

- 1 Find and tap **Settings > Sound > Do not disturb > Allowed in Priority only**.
- 2 Tap the switches to activate one or more options.

#### Hint

You can allow certain apps to bypass the priority. See *Notifications* on page 26.

### To block visual disturbances

- 1 Find and tap **Settings > Sound > Do not disturb > Block visual disturbances**.
- 2 Tap the switches to activate one or more options.

## Automatic rules

You can set automatic rules to activate Do not disturb mode for specific times or events.

### To set an automatic rule

- 1 Find and tap **Settings > Sound > Do not disturb**.
- 2 Tap an automatic rule, for example **Weekend**.
- 3 Tap the options to set the rule name, time and behaviours as desired.
- 4 Tap the switch to activate the rule.

#### Hint

To create a new rule, tap Add more and follow the on-screen instructions.

## Screen settings

You can change the screen's behaviour, brightness, viewing size and quality. For example, select a bigger font or display size for easier reading or change the icons you see in the status bar.

If you want to change your background, see *Background* on page 25. To change how long you want to have the screen on before it is turned off, see *Turning the screen on or off* on page 18.



### To change a screen setting

- 1 Find and tap **Settings > Display**.
- 2 Tap the setting you want to change.
- 3 Use the sliders, checkboxes or additional menus to adjust.

## Brightness level

Adjust the brightness level with the slider. You can also enable Adaptive brightness to automatically optimise brightness based on surrounding light.

## White balance

Use the sliders to adjust the white balance of your display. To revert to the default setting, tap Default values.

## Auto-rotate screen

Set the screen to rotate automatically when the device is turned, or set it to stay in portrait view.

## Screen pinning

Use screen pinning to set your device to display only the screen for a specific application. For example, if you are playing a game and you accidentally touch the home button, the screen pinning feature prevents the active game app screen from being minimised. You can also use this feature when you lend your device to another person to make it harder for them to access more than one application. For example, you can lend your device to somebody to take a photo and pin the screen to the Camera application so that the person can't easily use other applications such as Email.

### Note

Screen pinning is not a security feature and does not fully prevent other users from unpinning a screen and accessing your device. To protect your data, you should set up your device to request a screen lock PIN, password, or pattern before someone can unpin the screen.



### To enable or disable screen pinning

- 1 Find and tap **Settings > Lock screen & security > Screen-pinning**.
- 2 Tap the switch to enable or disable the function.



### Hint

A pattern, PIN or password is not mandatory for screen pinning to work.

### To pin a screen

- 1 Make sure that screen pinning is activated on your device.
- 2 Open an app and go to the screen that you want to pin.
- 3 Tap  (Recent apps button).
- 4 To display the screen pinning icon, swipe upwards and tap  (Screen pinning icon).
- 5 In the window that appears, tap **GOT IT**.

### To unpin a screen

- On the pinned screen, touch and hold  (Back button) and  (Recent apps button) until the screen is unpinned.

**Hint**

If you selected a security option when you activated the screen pinning function, you have to enter your pattern, PIN or password to unlock the device before the screen can be unpinned.

## Application settings

Some applications will ask for permissions once you start using them. You can allow or deny permissions individually for each app, either from the Settings menu or from the Permission confirm dialog. Permission requirements depend on the app's design.

### Allowing or denying permissions

You can choose whether to allow or deny permissions when the dialog is shown. If you have used another Android version previously, most applications will have already been granted the necessary permissions.

#### To allow a permission

- To allow a permission, tap **ALLOW**. You can mark the **Don't ask again** checkbox if you wish.

#### To deny a permission

- To deny a permission, tap **DENY** when the dialog is shown.

**Hint**

Some applications can still be used even if you have denied permissions.

### Critical permissions

Some permissions are mandatory for applications to work as intended. In such cases, a dialog will inform you.

#### To configure applications

- 1 Find and tap **Settings > Apps & notifications**.
- 2 Select a configuration option. For example, choose an application that you want to configure.

#### To allow critical permissions

- 1 Find and tap **Settings > Apps & notifications > App permissions**.
- 2 Select an option, then tap the relevant switch to adjust permissions.

### Allowing or denying automatic application updates

If the automatic update feature is enabled, your applications get updated without you being asked, so you may not realise that large volumes of data are being downloaded. In order to avoid potentially high data transfer costs, you can disable automatic updates or enable automatic updates only over Wi-Fi connection. You have to disable the automatic update feature in the Play Store app to avoid the automatic updating of applications.

#### To enable or disable automatic updates for all applications in the Play Store

- 1 Find and tap ► (Play Store icon).
- 2 Tap ≡ (Options icon), then tap **Settings > Auto-update apps**.
- 3 Select the preferred option.

## Application linking

Your device can determine the default app to handle a particular web link. This means that if the link is set, you don't need to select an app each time you open a link. You can change the default app any time you want.

### To manage app links from the Settings menu

- 1 Find and tap **Settings > Apps & notifications**.
- 2 Tap **Advanced > Default Apps > Opening links**.
- 3 Select an app, and adjust the settings as desired.

## Resetting your applications

You can reset an application or clear application data if your application stops responding or causes issues with your device.

### To reset application preferences

- 1 Find and tap **Settings > Apps & notifications**.
- 2 Tap > (See all apps icon) to see all applications.
- 3 Tap ⋮ (Menu icon) > **Reset app preferences > Reset apps**.

#### Hint

Resetting application preferences does not delete any application data from your device.

### To clear application data

- 1 Find and tap **Settings > Apps & notifications**.
- 2 Select an application or service, then tap **Storage > CLEAR DATA > OK**.

#### Note

When you clear application data, data for the selected application is deleted from your device permanently. The option to clear application data is not available for every application or service.

### To clear application cache

- 1 Find and tap **Settings > Apps & notifications**.
- 2 Select an application or service, then tap **Storage > CLEAR CACHE**.

#### Note

The option to clear the application cache is not available for every application or service.

### To clear the application default setting

- 1 Find and tap **Settings > Apps & notifications**.
- 2 Select an application or service, then tap **Open by default > CLEAR DEFAULTS**.

#### Note

The option to clear the application default setting is not available for every application or service.



## Language settings

You can select a default language for your device and change it again at a later time. You can also change the writing language for text input.

### To change the language

- 1 Find and tap **Settings > System > Languages & input > Languages**.
- 2 To change the language, drag and drop the desired language to the top of the list. If the desired language is not currently listed, tap + (Add icon) to add it.

**Note**

If you select the wrong language and cannot read the menu texts, find and tap  (Settings icon) >  (System menu icon). Then select the text beside  (Keyboard icon) and select the first entry in the menu that opens. You can then select the language you want.

## Date and time

You can change the date and time on your device.

### To set the date manually

- 1 Find and tap **Settings > System > Date & time**.
- 2 Disable the **Automatic date & time** function by tapping the switch.
- 3 Tap **Set date**.
- 4 Swipe left or right, or use the arrows to set the desired date.
- 5 Tap **OK**.

### To set the time manually

- 1 Find and tap **Settings > System > Date & time**.
- 2 Disable the **Automatic date & time** function by tapping the switch.
- 3 Tap **Set time**.
- 4 Select the relevant values for the hour and minute.
- 5 Tap **OK**.

### To set the time zone manually

- 1 Find and tap **Settings > System > Date & time**.
- 2 Disable the **Automatic time zone** function by tapping the switch.
- 3 Tap **Select time zone**.
- 4 Select an option.

## Multiple user accounts

Your device supports multiple user accounts. The user who sets up the device for the first time becomes the owner of the device. Only the owner can manage the accounts of other users.

Find and tap Settings > Users & accounts > Users > Add user, then the owner creates two types of accounts:

- Regular User: This account type is suitable for someone who regularly uses your device.
- Guest User: Enable the guest account option for someone who just wants to use your device temporarily.

**Note**

Some features are only available to the owner. For example, updating software or transferring data. These features are not appeared in the menu when logging in Regular User or Guest User.

### To switch between multiple user accounts

- 1 Drag the status bar downwards using two fingers then tap  (User icon).
- 2 Tap the icon representing the user account that you want to switch to. The lock screen for that user account appears.

# Typing text

## On-screen keyboards

There are a number of pre-installed text entry providers on your device.

### Note

The default text entry provider may depend on the regional or language settings you use. One or more text entry providers might not be available in your region.

## SwiftKey® keyboard

You can enter text using the on-screen keyboard by tapping each letter individually, or you can use the SwiftKey flow feature and slide your finger from letter to letter to form words.

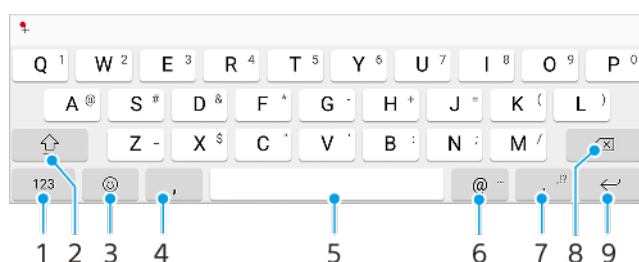

- 1 Display numbers and symbols
- 2 Switch between lower case, upper case and all caps
- 3 Access emojis
- 4 Enter a comma
- 5 Enter a space
- 6 Enter a domain name
- 7 Enter punctuation
- 8 Delete
- 9 Enter a carriage return

### Hint

- To enter a full stop, double-tap the space bar after you enter a word.
- For more information about SwiftKey, go to <https://swiftkey.com/>.

### To switch between different on-screen keyboard options

- 1 Find and tap **Settings > System > Languages & input > On-screen keyboard**.
- 2 Tap **Manage keyboards**, then tap the switch to enable or disable the keyboard.

### To enter text using the gesture input function

- 1 When the on-screen keyboard is displayed, slide your finger from letter to letter to trace the word that you want to write.
- 2 After you finish entering a word, lift up your finger. A word suggestion appears based on the letters that you have traced.
- 3 If the word that you want does not appear, tap **⌫** (Backspace icon) to see other options and select accordingly. If the desired option does not appear, delete the entire word and trace it again, or enter the word by tapping each letter individually.

## Editing text

You can select, cut, copy and paste text as you write. You can access the editing options by double-tapping the entered text. The editing options then become available via an application bar.

## Application bar

The following actions are available on the selected text:

- Cut
- Copy
- Paste
- Share
- Select all

### Note

The Paste option only appears when you have text saved on the clipboard.

# Calling

## Making calls

You can make a call by dialling a phone number manually, or use the smart dial function to quickly find numbers from your contacts list and call logs. To make a video call, you can use the Duo video chat application on your device.

Dual SIM users can set a default SIM card for placing calls, or have the option to select the SIM card each time you place a call. Find and tap Settings > Network & Internet > Dual SIM > Calls to select an option.

## Making calls overview

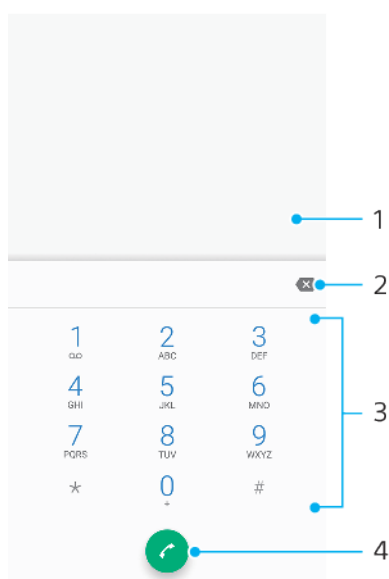

- 1 Display smart dial and options
- 2 Delete
- 3 Dialpad
- 4 Call button

### To open the dialpad

- 1 Find and tap ☎ (Phone icon).
- 2 If the dialpad does not appear, tap 📞 (Dialpad icon).

### To dial a phone number



- 1 Find and tap ☎ (Phone icon).
- 2 If the call log appears, tap 📞 (Dialpad icon) to display the dialpad.
- 3 Enter the phone number, and tap 📞 (Call button).
- 4 Dual SIM users, select a SIM card if prompted.

### To make a call using smart dial

- 1 Find and tap ☎ (Phone icon).
- 2 If the call log appears, tap 📞 (Dialpad icon) to display the dialpad.
- 3 Use the dialpad to enter letters or numbers that correspond to the contact you want to call. As you enter each letter or number, a list of possible matches appears.
- 4 Tap the contact that you want to call.

- 5 Dual SIM users, select a SIM card if prompted.



#### To make an international call

- 1 Find and tap  (Phone icon). The call log is displayed.
- 2 Tap  (Dialpad icon) to display the dialpad.
- 3 Touch and hold 0 until a “+” sign appears.
- 4 Enter the country code, the area code without the initial zeros, followed by the phone number. Then tap  (Call button).
- 5 Dual SIM users, select a SIM card if prompted.

#### To add a direct dial number to your Home screen

- 1 Touch and hold an empty area on your Home screen.
- 2 In the customisation menu, tap **Shortcuts**.
- 3 Scroll through the list of applications and select **Direct dial**.
- 4 Select the contact and the number that you want to use as the direct dial number.

#### To show or hide your phone number during outgoing calls

- 1 Find and tap  (Phone icon).
- 2 Tap  (Menu icon) > **Settings**.
- 3 Dual SIM users, tap **Calling accounts**, and select a SIM card. Single SIM users, tap **Calls**.
- 4 Tap **Additional settings** > **Caller ID**, and choose an option.

#### Note

This option may not be provided by every operator.

## Receiving calls

If you receive an incoming call when the device is in sleep mode or the screen is locked, the phone application opens in full screen format. For Dual SIM devices, the screen background colour indicates which SIM card the call is for. The background colour can be changed in Call settings.

If you receive an incoming call when the screen is active, the incoming call is displayed as a notification that appears on the top of whatever screen is open. If you are using a Dual SIM device, SIM card information is also displayed. When the notification arrives, you can choose to answer the call and open the phone application screen, or you can reject the call and stay on the current screen.

#### To answer a call when the screen is inactive

- When a call comes in, swipe  (Incoming call icon) up.

#### To answer a call when the screen is active

- When a call comes in, in the heads-up notification that appears at the top of the screen, tap **ANSWER**.

#### Hint

Instead of answering the call, you can go to the main phone application screen by tapping the heads-up notification window. Using this method, you get more options to manage the call. For example, you can decide to reject the call with a message.

#### To reject a call when the screen is inactive

- When a call comes in, swipe  (Incoming call icon) down.

#### To reject a call when the screen is active

- When a call comes in, in the heads-up notification that appears at the top of the screen, tap **DECLINE**.



#### Hint

Instead of rejecting the call, you can go to the main phone application screen by tapping the heads-up notification window. This way you get more options to manage the call. For example, you can decide to reject the call with a message.

#### To mute the ringtone for an incoming call

- When you receive the call, press the volume key.

### Rejecting a call with a text message

You can reject a call with a text message, sent automatically to the caller and stored in the Messaging conversation with the contact.

You can select from a number of predefined messages available on your device, or you can create a new message. You can also create your own personalised messages by editing the predefined ones.

#### To reject a call with a text message when the screen is inactive

- 1 When an incoming call arrives, drag  (Reject with reply icon) to the centre of the screen.
- 2 Select a predefined message or tap **Write new message**.



#### To reject a call with a text message when the screen is active

- 1 When an incoming call arrives, tap the heads-up notification window where the phone number or the name of the contact is displayed.
- 2 Drag  (Reject with reply icon) to the centre of the screen.
- 3 Select a predefined message or tap **Write new message**.

#### To reject a second call with a text message

- 1 When you hear repeated beeps during a call, drag  (Reject with reply icon) to the centre of the screen.
- 2 Select a predefined message or tap **Write new message**.

#### To edit the text message used to reject a call



- 1 Find and tap  (Phone icon).
- 2 Tap  (Menu icon) > **Settings**.
- 3 Dual SIM users, tap **Calling accounts**, and select a SIM card. Single SIM users, tap **Calls**.
- 4 Tap **Reject call with message**.
- 5 Tap the message that you want to edit, then make the necessary changes.
- 6 Tap **OK**.

### Forwarding calls



You can direct calls to a different recipient, for example, to another phone number or another device.

If you are using a Dual SIM device, you can also forward calls that come in on SIM card 1 to SIM card 2 when SIM card 1 is unreachable, and vice versa. This function is called Dual SIM reachability. You must enable it manually.

#### To forward calls

- 1 Find and tap  (Phone icon).
- 2 Tap  (Menu icon) > **Settings**.
- 3 Dual SIM users, tap **Calling accounts**, and select a SIM card. Single SIM users, tap **Calls**.
- 4 Tap **Call forwarding**, then select an option.
- 5 Enter the number you want to forward calls to, then tap **Turn on**.

### To turn off call forwarding

- 1 Find and tap  (Phone icon).
- 2 Tap  (Menu icon) > **Settings**.
- 3 Dual SIM users, tap **Calling accounts**, and select a SIM card. Single SIM users, tap **Calls**.
- 4 Tap **Call forwarding**.
- 5 Select an option, then tap **Turn off**.

### To enable the Dual SIM reachability function

#### Note

This function only applies for Dual SIM devices.

- 1 Find and tap **Settings** > **Network & Internet** > **Dual SIM** > **Dual SIM reachability**.
- 2 Under **Dual SIM reachability**, tap the switch to enable the function.
- 3 Follow the on-screen instructions to complete the procedure.

#### Hint

If the Dual SIM reachability function does not work after you enable it, check that you have entered the phone numbers correctly for each SIM card. In some cases, the numbers are detected automatically during setup. Otherwise, you are prompted to enter them manually.



## Blocking a number

You can block numbers from calling you and from sending you messages. Select from stored numbers or type in a number yourself.



### To block a stored number

- 1 Find and tap  (Phone icon).
- 2 Touch and hold the number you want to block.
- 3 Tap **Block number**, then tap **BLOCK**. Calls and texts from this number are blocked.

### To block a number by typing the number

- 1 Find and tap  (Phone icon).
- 2 Tap  (Menu icon) > **Settings** > **Block numbers** > **Add a number**.
- 3 Enter the phone number you want to block, then tap **BLOCK**. Calls and texts from this number are blocked.

### To unblock a blocked number



- 1 Find and tap  (Phone icon).
- 2 Tap  (Menu icon) > **Settings** > **Block numbers**.
- 3 Tap  (Cancel icon) next to the phone number you want to unblock, then tap **UNBLOCK**. Calls and texts from this number are no longer blocked.

# Contacts

## Adding and editing contacts

You can add, edit or delete contacts on your device and from synchronised accounts. Add contact pictures or set individual ringtones to personalise contacts. You can also edit contact information about yourself.

### To add a contact

- 1 Find and tap  (Contacts icon).
- 2 Tap  (Add new contact icon).
- 3 If you're adding a contact for the first time and have multiple accounts synchronised to your device, select an account. This becomes the default account for saving your contacts. Later you can select where to save the contact by tapping  (Add new contact icon) > **Saving to**.
- 4 Enter or select the desired information for the contact.
- 5 When you're finished, tap **SAVE**.



#### Note

To change the default setting for saving your contacts, tap  (Options icon) and select the new account. Alternatively, select Phone contact to save contacts only to your device. To move an existing contact to a new account, you must create the contact again and save it to the new account.

#### Hint

If you add a plus sign and the country code before a contact's phone number, you do not have to edit the number again when you make calls from abroad.



### To edit a contact

- 1 Find and tap  (Contacts icon).
- 2 Tap the contact that you want to edit, then tap  (Edit icon).
- 3 Edit the desired information.
- 4 When you are finished, tap **SAVE**.

#### Note

Some synchronisation services do not allow you to edit contact details.



### To add or remove a contact picture

- 1 Find and tap  (Contacts icon).
- 2 Tap the contact that you want to edit, then tap  (Edit icon).
- 3 Tap  (Camera icon), then select an option.
- 4 After the picture is updated, tap **SAVE**.



#### Hint

You can also add a picture to a contact directly from the Album application.



### To personalise the ringtone for a contact

- 1 Find and tap  (Contacts icon).
- 2 Tap the contact that you want to edit, then tap  (Menu icon) > **Set ringtone**.
- 3 Select a ringtone or tap + (Add icon) to select a music file saved on your device.
- 4 Tap **OK**.



### To send all calls to voicemail for a contact

- 1 Find and tap  (Contacts icon).
- 2 Select the desired contact.
- 3 Tap  (Menu icon) > **Route to voicemail**.



### To delete contacts

- 1 Find and tap  (Contacts icon).
- 2 Touch and hold the contact that you want to delete.
- 3 Tap , then tap **DELETE**.
- 4 To delete several or all contacts, mark the checkboxes beside the contacts that you want to delete.
- 5 Tap , then tap **DELETE**.

### To edit contact information about yourself

- 1 Find and tap  (Contacts icon).
- 2 Tap  (Options icon) > **My info**.
- 3 Tap , then enter the new information or make the changes you want.
- 4 When you are finished, tap **SAVE**.



### To create a new contact from a text message

- 1 Find and tap  (Messages icon).
- 2 Select a phone number, then tap  (Menu icon) > **Add contact**.
- 3 Select an existing contact, or tap **Create new contact**.
- 4 Edit the contact information and tap **SAVE**.



## Grouping contacts

You can create contact labels to organise groups of related contacts. You can name your groups as "Family" or "Friends" to differentiate them from your other contacts.

### To create a new label for a group

- 1 Find and tap  (Contacts icon).
- 2 Tap  (Options icon), then tap **Create label**.
- 3 Select where to store your contacts.
- 4 Type a Label name, then tap **OK**.

### To delete a group label

- 1 Find and tap  (Contacts icon).
- 2 Tap  (Options icon), then tap the label you want to delete.
- 3 Tap  (Menu icon), then tap **Delete label**.

## Transferring contacts

There are several ways to transfer contacts to your new device. You can synchronise contacts from an online account or import contacts directly from another device.



If you synchronise the contacts in your old device with an online account, you can transfer your contacts to your new device using that account.

You can also copy contacts to a memory card, use Bluetooth technology, or save contacts to a SIM card. For more specific information about transferring the contacts from your old device, refer to the relevant User guide.

## Transferring contacts using an online account

If you synchronise the contacts in your old device or your computer with an online account, for example, Google Sync™ or Microsoft Exchange ActiveSync, you can transfer your contacts to your new device using that account.

### To turn auto-sync data on or off

- 1 Find and tap  (Contacts icon).
- 2 Tap  (Options icon), then tap **Settings**.

- 3 Tap **Accounts**, then tap the **Automatically sync data** switch to enable or disable the function.
- 4 Tap **OK**.



**Note**

You need to be signed in to the relevant sync account before you can synchronise your contacts with it.

## Other methods for transferring contacts

There are several other ways to transfer contacts from your old device to your new device. For example, you can copy contacts to a memory card, or use Bluetooth technology. For more specific information about transferring the contacts from your old device, refer to the relevant User guide.



### To import contacts from a memory card

- 1 Find and tap  (Contacts icon).
- 2 Tap , then tap **Settings > Import > SD card or internal storage (.vcf file)**.
- 3 Select where to store your contacts.
- 4 Tap , then select **SD card**.
- 5 Select the files that you want to import by tapping them.

### To import contacts using Bluetooth

- 1 Make sure you have the Bluetooth function turned on and that your device is set to visible.
- 2 When you are notified of an incoming file to your device, drag the status bar downwards and tap the notification to accept the file transfer.
- 3 Tap **Accept** to start the file transfer.
- 4 Drag the status bar downwards. When the transfer is complete, tap the notification.
- 5 Tap the received file and select where to store your contacts.



### To import contacts from a SIM card

- 1 Find and tap  (Contacts icon).
- 2 Tap , then tap **Settings > Import**.
- 3 Single SIM users, tap **Import from SIM card**. Dual SIM users, select a SIM card.
- 4 Select where to store your contacts.
- 5 Select contacts to import, then tap **Import**.

## Backing up contacts

You can use internal storage, a memory card or a SIM card to back up contacts.

### To export all contacts to a memory card

- 1 Find and tap  (Contacts icon).
- 2 Tap  (Options icon) > **Settings > Export > to SD card or internal storage (.vcf file)**.
- 3 Tap  (Options icon) > **SD card**.
- 4 Select a destination folder, then tap **SAVE**.

### To export contacts to a SIM card

**Note**

When you export contacts to a SIM card, not all information may get exported. This is due to memory limitations on SIM cards.

- 1 Find and tap  (Contacts icon).

- 2 Tap ≡ (Options icon) > **Settings** > **Export**.
- 3 Single SIM users, tap **Export to SIM card**. Dual SIM users, select a SIM card to export to.
- 4 Tap **OK**.
- 5 Select contacts to export, then tap **Export**.
- 6 Select an option, then tap **OK**.

#### To export all contacts to internal storage

- 1 Find and tap 👤 (Contacts icon).
- 2 Tap ≡ (Options icon) > **Settings** > **Export** > **to SD card or internal storage (.vcf file)**.
- 3 Tap ⋮ (Menu icon) > **Show internal storage**.
- 4 Tap ≡ (Options icon), then tap your device's model number beside 🗄️ (Internal storage icon).
- 5 Select a destination folder or simply tap **SAVE**.

# Messaging and chat

## Reading and sending messages

The Messages application shows your messages as conversations, which means that all messages to and from a particular person are grouped together.

### Note

The number of characters that you can send in a single message varies depending on the operator and the language you use. The maximum size of a multimedia message, which includes the size of added media files, is also operator dependent. Contact your network operator for more information.

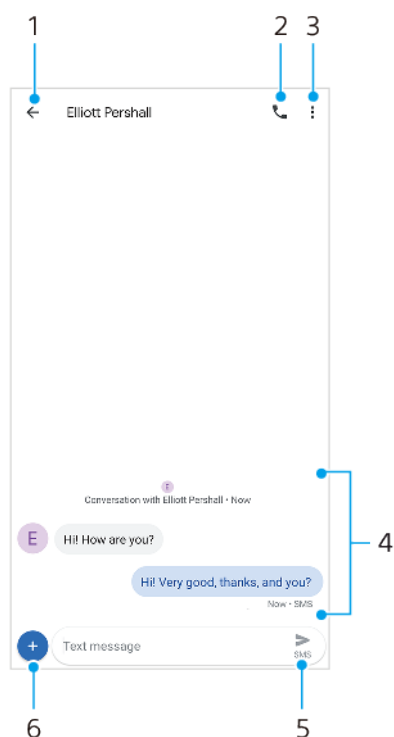

## Messaging overview



- 1 Go back to the list of conversations
- 2 Call the message sender
- 3 View menu options
- 4 Sent and received messages
- 5 Send a completed message
- 6 Add attachments

### To create and send a message

- 1 Find and tap (Messages icon).
- 2 Tap (New message icon).
- 3 Enter the recipient's name or phone number, then select from the suggestions that appear. If the recipient is not listed as a contact, enter the recipient's number manually.
- 4 If you want to send a group message, tap (Add recipient icon) to add more recipients.
- 5 Dual SIM users, tap (Select SIM icon) to select the SIM card you wish to use.

- 6 Enter your message text. If you want to add an attachment, tap  (Add icon) and select the relevant attachment option.
- 7 To send the message, tap .

**Hint**

If you exit a message before sending, it gets saved as a draft. The conversation gets tagged with the word Draft.



### To read a received message

- 1 Find and tap .
- 2 Tap the desired conversation.
- 3 If the message is not yet downloaded, tap it.





**Hint**

All received messages are saved by default to the device memory.

### To reply to a message

- 1 Find and tap .
- 2 Tap the conversation containing the message.
- 3 Dual SIM users, tap  (Select SIM icon) to select the SIM card you want to use.
- 4 Enter your reply and tap .

### To forward a message

- 1 Find and tap .
- 2 Tap the conversation containing the desired message.
- 3 Dual SIM users, tap  (Select SIM icon) to select the SIM card you want to use.
- 4 Touch and hold the desired message, then tap .
- 5 Select a recent contact from the list or tap **New message** and enter the recipient's name or phone number, then select from the suggestions that appear. If the recipient is not listed as a contact, enter the recipient's number manually.
- 6 Edit the message if necessary, then tap .



### To save a file contained in a received message

- 1 Find and tap .
- 2 If the message has not been downloaded yet, tap it.
- 3 Touch and hold the file that you want to save, then select the desired option.



## Messaging settings

You can change message notification settings and select whether to enable message delivery reports.

### To change your message notification settings

- 1 Find and tap .
- 2 Tap , then tap **Settings**.
- 3 Dual SIM users, tap **General**.
- 4 To set a notification sound, tap **Notifications** > **Sound**, then select an option or tap  (Add icon) and select a music file that is saved on your device.
- 5 To confirm, tap **OK**.
- 6 To adjust additional notification settings, tap the switches.

### To enable or disable delivery reports for outgoing messages

- 1 Find and tap .
- 2 Tap , then tap **Settings**.
- 3 Dual SIM users, select a SIM card. Single SIM users, tap **Advanced**.
- 4 Tap the **Get SMS delivery reports** switch to enable or disable the function.



**Note**

After delivery reports are turned on, the text “Delivered” is displayed for messages that have been successfully delivered.

## Setting up email

Use the email application  (Email icon) on your device to send and receive email messages through your email accounts. You can have one or several email accounts at the same time, including corporate Microsoft Exchange ActiveSync accounts.

# Music and FM radio

## Transferring music from a computer to your device

There are two ways to transfer music from a computer to your device:

- Connect your device to a computer using a USB Type-C cable. Select Transfer files on your device and then copy and paste or drag and drop the files using the computer.
- On the computer, save your media files using Google Drive. Then, synchronise the data on your device by logging in to the Google account.

### Note

The Music application may not support all music file formats.

## Listening to music

Use the Music application to listen to your favourite music.

## Music player overview

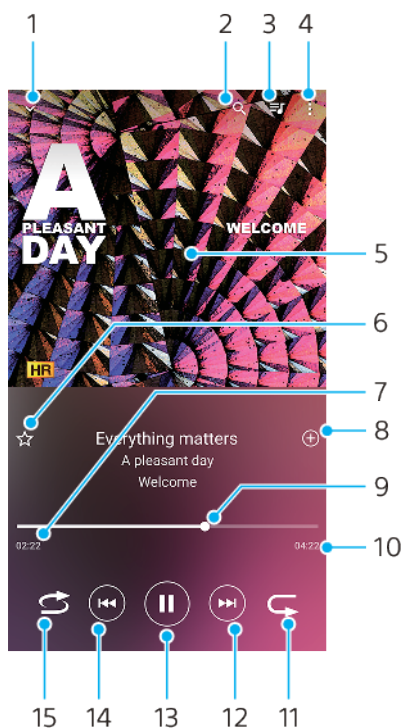

- 1 Minimise the full screen player
- 2 Search all songs saved to your device
- 3 View the play queue
- 4 View menu options
- 5 Album art (if available)
- 6 Add or remove a song as a favourite
- 7 Elapsed time of current song
- 8 Add a song to a playlist
- 9 Progress indicator – drag or tap along the line to fast-forward or rewind
- 10 Length of current song
- 11 Repeat the current song or all songs in the play queue

- 12 Tap to go to the next song, touch and hold to fast-forward the current song
- 13 Play or pause a song
- 14 Tap or double-tap to go to the beginning of the current song or the previous song, touch and hold to rewind the current song
- 15 Shuffle songs in the play queue

**Hint**

How to use ⏮ (Previous button) while playing a song.

- During the first 5 seconds of playback, tap the button to go back to the previous song.
- After 5 seconds of playback, tap the button to go back to the beginning of the current song, or double-tap it to go back to the previous song.

## Music home screen

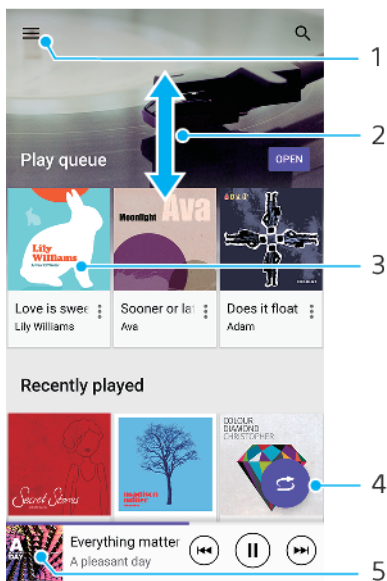

- 1 Open the Music menu
- 2 Scroll up or down to view content
- 3 Tap to start playing a song in the play queue
- 4 Play all songs in shuffle mode
- 5 Go to the music player screen

**Note**

You might not be able to play copyright-protected items. Make sure that you have the necessary rights for the content you wish to use.

### To edit music information and download album art

- 1 While a song is playing in the Music application, tap the album art in the music player screen and then tap **Edit music info**.
- 2 Edit the information as desired.
- 3 To set or download album art, tap ✎ (Edit icon), then select an option.
- 4 When you are finished, tap **SAVE**.

### To minimise the Music application

- When a song is playing, tap ● (Home button) to go to the Home screen. The Music application keeps running in the background.

### To open the Music application when it is playing in the background

- While a song is playing in the background, drag the status bar downwards and tap the Music notification.
- Alternatively, find and tap  (Music icon).

## Listening to the radio

The FM radio in your device works like any FM radio. For example, you can browse and listen to FM radio stations and save them as favourites. You must connect a wired headset or headphones to your device before you can use the radio. This is because the headset or headphones act as an antenna. After one of these devices is connected, you can then switch the audio to the speaker, if desired.

### FM radio overview

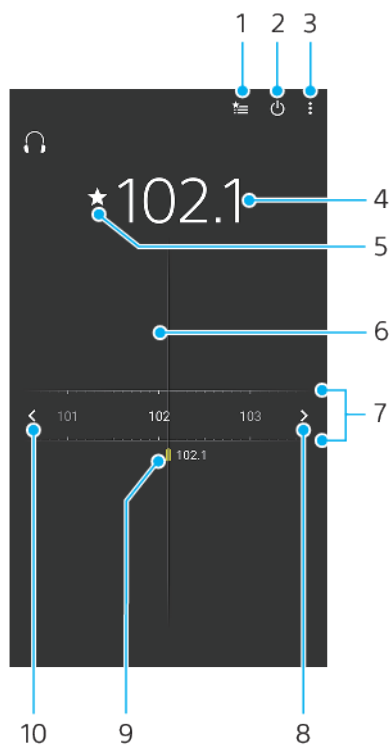

- 1 Favourites list
- 2 Radio on/off button
- 3 View menu options
- 4 Tuned frequency
- 5 Save or remove a channel as a favourite
- 6 Tuning dial
- 7 Frequency band – drag left or right to move between channels
- 8 Move up the frequency band to search for a channel
- 9 A saved favourite channel
- 10 Move down the frequency band to search for a channel

### To listen to the FM radio

- 1 Connect a headset or a set of headphones to your device.
- 2 Find and tap  (FM radio icon). The available channels appear as you scroll through the frequency band.

**Note**

When you start the FM radio, available channels appear automatically. If a channel has RDS information, it appears a few seconds after you start listening to the channel.

**To move between radio channels**

- Drag the frequency band left or right.
- Alternatively, tap the arrows on either side of the band to jump to the next clear radio signal.

**To start a new search for radio channels**

- 1 When the radio is open, tap  (Menu icon).
- 2 Tap **Search for channels**. The radio scans the whole frequency band and marks all available channels.

**To switch the radio sound to the speaker**

- 1 When the radio is open, tap  (Menu icon).
- 2 Tap **Play in speaker**.

**Hint**

To switch the sound back to the wired headset or headphones, tap  (Menu icon) and tap Play in headphones.

# Camera

## Getting to know your camera

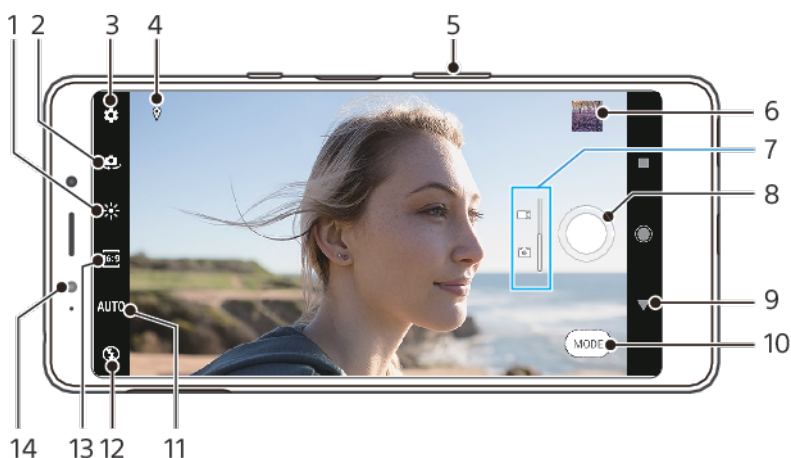



- 1 Colour and brightness
- 2 Switch between the front and main camera
- 3 Camera settings
- 4 Save your location
- 5 Use the volume keys to zoom in or out
- 6 Tap the thumbnail to view, share, or edit photos and videos
- 7 Switch between taking photos and videos
- 8 Use the shutter button to take photos or record videos
- 9 Go back or exit the camera
- 10 Select a capturing mode
- 11 Scene selection menu
- 12 Flash settings
- 13 Select an aspect ratio
- 14 Front camera lens

### Basic camera tips

- Make sure the lens is clean. A fingerprint or a little dirt can diminish photo quality.
- Use the self-timer when you need extra time to prepare, or to avoid blurred photos.
- Check your device's memory status often. High-resolution photos and videos consume more memory.





### To launch the camera

- Swipe  (Camera icon) from the lock screen.
- Tap  (Camera icon) from the Application screen.
- Press the power key twice.

### Shutter button

The shutter button is used differently depending on the capturing mode and activated features.

## Shutter button overview

-  Take a photo
-  Record a video
-  Stop recording a video
-  Self-timer is activated

### To change the aspect ratio

- 1 While using the camera, tap  (Aspect ratio icon).
- 2 Select a setting.

### To adjust the camera settings

- 1 While using the camera, tap  (Settings icon).
- 2 Swipe the list to view the available settings and select a setting.

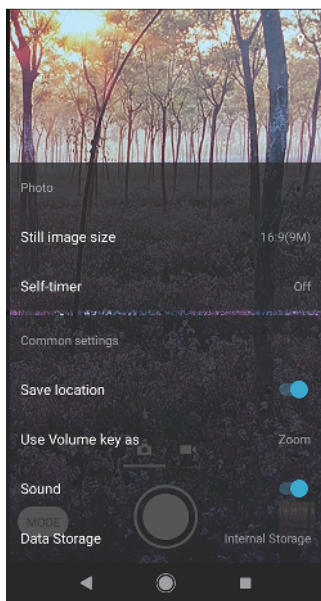

#### Note

Available settings depend on the capturing mode selected.

### To view, share or edit photos and videos

- 1 When using the camera, tap the thumbnail to open a photo or video.
- 2 Swipe left or right to view your photos and videos.
- 3 Tap the screen to edit a photo or video.

#### Hint

Your photos and videos are stored in the Album application. See *Viewing photos and videos* on page 79 for more options.

## Capturing modes

You can select capturing modes by tapping Mode.

#### Note

Available settings depend on the capturing mode selected.

## Capturing modes overview

The following are some of the main capturing modes.

- **Bokeh**  
Take photos with a blurred effect
- **Portrait selfie**  
Take better-looking selfies
- **Panorama**  
Take wide-angle and panoramic photos

### To switch between taking photos and videos

- While using the camera, swipe the screen to select a photo or video mode.

### To select a capturing mode

- When using the camera, tap **Mode** and select a capturing mode.

### To switch between the main and front camera

- When using the camera, tap  (Switch camera icon) to switch between the main and front camera.

#### Hint

You can also switch between cameras by swiping down the camera screen.

### To use the zoom

- Pinch in or out on the camera screen.
- Use the volume key.

#### Hint

If you zoom in three or more times, this can affect image quality. Instead, take the photo without zoom, then crop it.

### To take a photo

- Tap the shutter button.

### To record a video

- 1 When using the camera, swipe the screen to select  (Record icon).
- 2 Tap the shutter button to start or stop recording.

### To take a photo with preset settings according to the scene

- 1 While using the camera, tap the scene selection icon, for example **SCN** or **AUTO**.
- 2 Select an option.

## Self-timer

Use the Self-timer to get more time to prepare for a photo. It also helps to keep your device steady and avoid blurred photos.

### To use the self-timer with the main camera

- 1 When using the main camera, tap  (Settings icon).
- 2 Tap **Self-timer** and select the delay time.
- 3 Close the settings menu. The Self-timer setting is saved.
- 4 Tap the shutter button to take a photo. A series of beeps marks the countdown until the photo is taken.



## Exposure, colour and light conditions

Good exposure for your photos requires the right amount of light. The camera automatically detects and adjusts to ambient light conditions.

Different exposures are required, for example, when taking photos of faces, moving objects or in low light.

### Optimising light conditions

- Look for light with direction and colour that gives a scene shape and depth. This type of light occurs just before sunrise and at sunset. Natural light from a window is also good.
- For higher quality photos in low light, you need to keep the camera steady. You can place the camera on a solid surface and use the self-timer.
- Even if light conditions are poor, try to take photos with and without the flash. Sometimes the quality is better without the flash.

#### To use the flash

- 1 When using the camera, tap the flash icon displayed on the screen, for example  (Auto flash icon).
- 2 If required, change the flash setting.
- 3 Tap the shutter button to take a photo or record a video.

#### Note

Available settings depend on the capturing mode selected.

#### Hint

When the background is brighter than the object, use Fill flash to remove unwanted dark shadows.



## Colour, brightness and exposure value

Your camera automatically adjusts the colour, brightness and exposure value by detecting the light conditions and estimating the colour temperature of ambient light. Digital cameras can only estimate the colour temperature, so you may need to adjust the settings to get it correct.

If you experience yellow-coloured photos in indoor environments or bluish photos when using the flash, try adjusting the colour.

To achieve better exposures in low-light environments, change the brightness for photos and videos.

#### To adjust the colour and brightness

- 1 When using the camera, tap  (Colour and brightness icon).
- 2 Drag the sliders to adjust the colour and brightness.
- 3 Tap the shutter button to take a photo or record a video.
- 4 Tap  (Cancel icon) to reset and close the colour setting.

## Shutter speed

Shutter speed refers to how long the shutter is open and the camera sensor is exposed to light.

A fast shutter speed helps to freeze motion, while a slow shutter speed can create an effect called "motion blur", where moving objects appear blurred along their line of motion.

The shutter speed is automatically adjusted in photos and videos.

## ISO

ISO determines how sensitive your camera is to light. A low ISO number means lower sensitivity, and a high ISO number means higher sensitivity. Higher sensitivity can add blur to your photos.

Choose a higher ISO value when taking photos of moving objects or when taking photos in low light without the flash.

If there is too much light, use the lowest ISO setting to achieve a higher image quality.

ISO is automatically adjusted when taking photos and videos.

## White balance

White balance is automatically adjusted when taking photos and videos.

## Optimising exposure

Exposure metering measures the amount of light that strikes an object, to optimise exposure.

Exposure metering is automatically adjusted when taking photos and videos.

## People, selfies and smiling faces

Faces in focus are indicated with a coloured frame.



## Taking photos and videos of people

- Consider the camera orientation. Use portrait for close-up photos, to fill the frame. Use landscape for close-up group photos, or to capture an object in the background.
- Place the camera on a solid surface and use the self-timer ⌚ to prevent blurred photos.

### To take a selfie

- 1 When using the camera, select a photo or video capturing mode for your selfie.
- 2 Tap 📷 (Switch camera icon) to activate the front camera.
- 3 Tap ⚙️ (Settings icon) > **Self-timer** if you want to use the self-timer.
- 4 Close the settings menu. The setting is saved for the capturing mode selected.
- 5 Tap the shutter button to take a selfie.

## Portrait selfie

Portrait selfie allows you to take better-looking selfies.

### Portrait selfie overview

- **Bokeh**  
Applies a blurring effect around the person
- ⚙️ **Soft Skin**  
Softens skin tones
- ✳️ **Skin brightness**  
Brightens skin tones
- 👁️ **Eye enlargement**  
Enlarges eyes
- 😊 **Slender face**  
Makes your face look slimmer

### To take a selfie with Portrait selfie

- 1 When using the camera, tap **Mode** > 📷 (Portrait selfie icon).
- 2 Tap the icon for the effect you want to apply, and drag the slider to adjust the effect. If desired, adjust the other effects in the same way.
- 3 Tap the shutter button to take a photo.

#### Hint

You can save your portrait in the same direction as the preview by tapping 🔄 (Mirroring icon) > On.

## Bokeh effect

You can take pictures with the Bokeh effect when using the dual camera on your device. The Bokeh effect decreases focus in the background of a photo to emphasise objects at the foreground, for an artistic effect.

### To take a photo with Bokeh effect

- 1 When using the camera, tap **Mode** > **Bokeh**.
- 2 To adjust the background defocus strength, tap 📷 (Dual camera effect icon) > 📷 (Bokeh icon). Drag the slider to adjust.
- 3 To adjust the brightness, tap ✳️ (Brightness icon). Drag the slider to adjust.
- 4 Tap the shutter button to take a photo.

#### Hint

If you get too close to or too far to an object while using the Bokeh effect, a warning message appears. If this happens, adjust the distance between your camera and the object to take the photo with Bokeh effect.



## Using various capturing modes

Use the capturing modes to take more creative photos and videos, and share them with your friends. You can create virtual scenes, panoramic photos, and more. You can also use capturing modes provided by Google.

## Bokeh

You can take pictures with the Bokeh effect when using the dual camera on your device. The Bokeh effect decreases focus in the background of a photo to emphasise objects at the foreground, for an artistic effect.

### To take a photo with Bokeh effect

- 1 When using the camera, tap **Mode** > **Bokeh**.
- 2 To adjust the background defocus strength, tap  (Dual camera effect icon) >  (Bokeh icon). Drag the slider to adjust.
- 3 To adjust the brightness, tap  (Brightness icon). Drag the slider to adjust.
- 4 Tap the shutter button to take a photo.

#### Hint

If you get too close to or too far from an object while using the Bokeh effect, a warning message appears. If this happens, adjust the distance between your camera and the object to take the photo with Bokeh effect.

## Panorama

Use the Panorama app to take wide-angle and panoramic photos.

### To take a panoramic photo

- 1 When using the camera, tap **Mode**.
- 2 Tap  (Panorama icon).
- 3 Tap the shutter button.
- 4 Move the camera slowly and steadily in the direction of movement indicated on the screen.

## Portrait selfie

Portrait selfie allows you to take better-looking selfies.

### Portrait selfie overview

- **Bokeh**  
Applies a blurring effect around a person
- ✦ **Soft Skin**  
Softens skin tones
- ✧ **Skin brightness**  
Brightens skin tones
- 👁 **Eye enlargement**  
Enlarges eyes
- 😊 **Slender face**  
Makes your face look slimmer

### To take a selfie with Portrait selfie

- 1 When using the camera, tap **Mode** >  (Portrait selfie icon).
- 2 Tap the icon for the effect you want to apply, and drag the slider to adjust the effect. If desired, adjust the other effects in the same way.
- 3 Tap the shutter button to take a photo.

#### Hint

You can save your portrait in the same direction as the preview by tapping  (Mirroring icon) > On.

## Resolution and memory

The number of photos and videos you can store depends on the resolution or MP (megapixel) value used and video length.

High-resolution photos and videos take up more memory, so keep in mind that a lower resolution can be suitable for everyday use.

Check the memory status from time to time. When the memory is full, you can transfer photos and videos to another storage device to free up memory. See *Backing up and synchronising with a Google account* on page 36.

Choose whether to store photos and videos on your device's internal storage or on an SD card using the Data storage option in the camera settings menu.

### To change the resolution

- 1 When using the camera, tap  (Settings icon).
- 2 Tap **Still image size** or **Video size**.
- 3 Select the resolution and close the settings menu. The setting is saved for the selected capturing mode.

#### Hint

You can set the resolution separately for each capturing mode.

## Additional camera settings



### Geotagging

You can save your photos and videos with the location where they were taken, this is called geotagging. The option to geotag your photos and videos requires a wireless network and that the GPS function is enabled.

### To turn on geotagging

- 1 When using the camera, tap  (Settings icon).
- 2 Tap the **Save location** switch to enable. The setting is saved.

### Geotagging status icons

-  The geographical position is saved.
-  The geographical position is not found.

## Different ways to use the volume key

You can change the way you use the volume key.

### To change how the volume key is used

- 1 When using the camera, tap  (Settings icon).
- 2 Tap **Use Volume key as** and select an option. The setting is saved.

## Volume key settings

**Zoom** Use the volume key to zoom in or out.

**Shutter** Use the volume key as a shutter button for photos and videos.

## Sound

When Sound is activated, the camera makes a sound when you take a photo or when you start or stop a video recording. Additionally, when you use the self-timer the countdown is indicated by a series of beeps.

### To activate or deactivate sound

- 1 When using the camera, tap  (Settings icon).
- 2 Tap the **Sound** switch to enable or disable. The setting is saved.

# Photos and videos in Album

## Viewing photos and videos

Use the Album application to view photos and play videos that you've taken with your camera, or to view similar content that you've saved to your device. All photos and videos are displayed in a chronologically ordered grid.

### Album overview

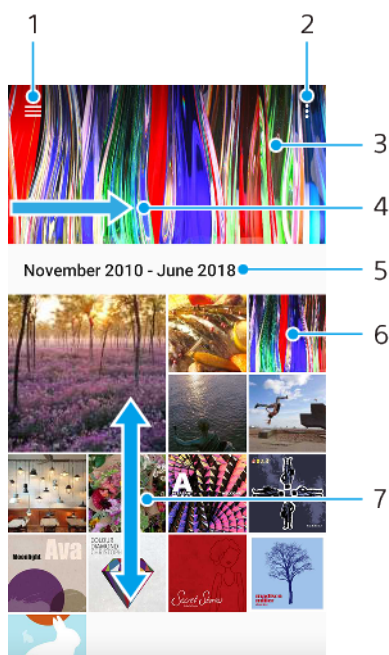

- 1 Open the Album home screen menu
- 2 View menu options
- 3 View a slideshow of your photos and videos
- 4 Swipe right to open the Album home screen menu
- 5 View date of items in the group
- 6 Tap a photo or video to view it
- 7 Scroll up or down to view content

### Album home screen menu

From the Album home screen menu you can browse your photo albums, including photos and videos taken using special effects. From the Album application, you can also perform basic editing tasks and use methods such as Bluetooth and email to share content.

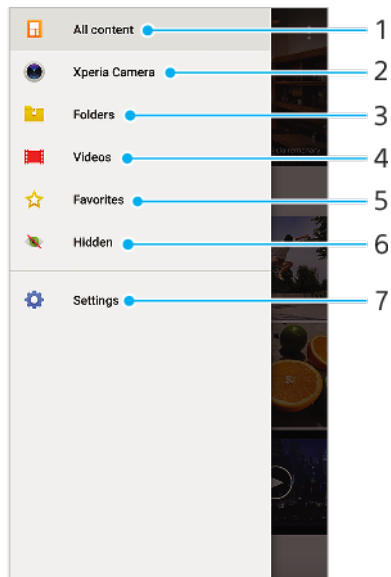

- 1 Return to the Album application home screen to view all content
- 2 View all photos and videos taken with your device's camera
- 3 View all photos and videos saved on your device in different folders
- 4 View all videos saved on your device
- 5 View your favourite photos and videos
- 6 View photos and videos that you have hidden from view
- 7 Open the Settings menu for the Album application



# Connectivity

## Connecting your device to USB accessories

You can use a USB Type-C host adapter to connect your device to USB accessories such as USB mass storage devices, game controllers, USB keyboards and USB mice. If the USB accessory has a USB Type-C connector, a USB Type-C host adapter is not necessary.

USB Type-C host adapters are sold separately. Sony does not guarantee that all USB accessories are supported by your device.

### Note

This device has a capless USB Type-C port. If your device gets exposed to water, ensure that the port is completely dry before connecting a USB Type-C cable.

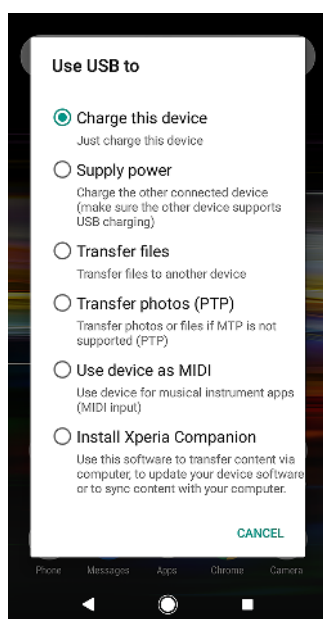

## USB connection mode

You can use the Transfer files connection mode for managing files and updating device software. This USB mode is used with Microsoft® Windows® computers. Charging is enabled by default.

You can also use your device as a Supply power, and charge the other connected device. Make sure that the other device supports USB charging.

Using the Use device as MIDI mode, your device can function as a MIDI input for musical instrument apps.

### To change USB connection mode

- 1 Attach a USB Type-C connector to your device.
- 2 Drag down the status bar, and then tap **USB charging this device**.
- 3 Tap the desired mode.

## NFC (Near Field Communication)

Use NFC to share data with other devices, such as videos, photos, web page addresses, music files, or contacts. You can also use NFC to scan tags that give you

more information about a product or service, and tags that activate certain functions on your device.

NFC is a wireless technology with a maximum range of one centimetre, so the devices sharing data must be held close to each other. Make sure that both devices have the NFC function turned on, and the both screens are active and unlocked.

The NFC detection area is located on the back of the device. Hold your device close to another device or an NFC reader so that the NFC detection areas touch.

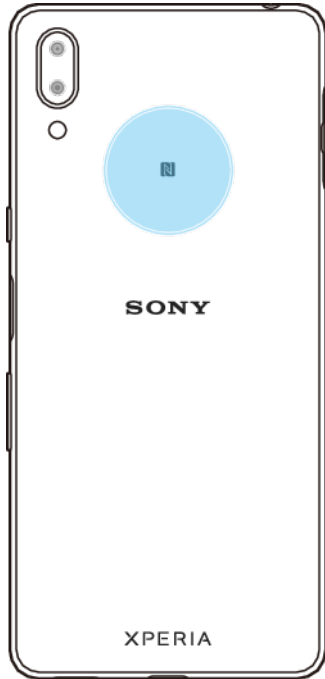

**Note**

NFC may not be available in all countries or regions. Using certain applications, some NFC functions can be enabled even when the device is switched off. Note that not all devices support this feature.

#### To enable or disable the NFC function

- 1 Find and tap **Settings > Device connection**.
- 2 Tap the **NFC** switch to enable or disable the function.

#### To share a contact with another device using NFC

- 1 To view contacts, find and tap **☰** (Contacts icon).
- 2 Tap the contact that you want to share.
- 3 Hold your device and the receiving device close to each other so that the NFC detection areas of each device touch. When the devices connect, a thumbnail of the contact appears.
- 4 Tap the thumbnail to start the transfer.
- 5 When the transfer is done, the contact information is saved on the receiving device and displayed on its screen.

#### To share a music file with another device using NFC

- 1 To open the Music application, find and tap **🎵** (Music icon).
- 2 Select a music category and browse to the track you want to share.
- 3 Tap the track to play it. You can then tap **⏸** (Pause icon) to pause the track. The transfer works whether the track is playing or paused.
- 4 Make sure the track is displayed on full screen.

- 5 Hold your device and the receiving device close to each other so that the NFC detection areas of each device touch. When the devices connect, a thumbnail of the track appears.
- 6 Tap the thumbnail to start the transfer.
- 7 When the transfer is done, the music file is saved on the receiving device.
- 8 To display the music file, drag down the status bar to open the Notification panel, and then tap **Beam complete**.

#### To share a photo or video with another device using NFC

- 1 To view photos and videos on your device, find and tap **Album**.
- 2 Tap the photo or video that you want to share.
- 3 Hold your device and the receiving device close to each other so that the NFC detection areas of each device touch. When the devices connect, a thumbnail of the photo or video appears.
- 4 Tap the thumbnail to start the transfer.
- 5 When the transfer is done, the photo or video is saved on the receiving device.
- 6 To display the photo or video, drag down the status bar to open the Notification panel, and then tap **Beam complete**.

#### To share a web address with another device using NFC

- 1 To open the web browser, find and tap  (Chrome icon).
- 2 Load the web page that you want to share.
- 3 Hold your device and the receiving device close to each other so that the NFC detection areas of each device touch. When the devices connect, a thumbnail of the web page appears.
- 4 Tap the thumbnail to start the transfer.
- 5 When the transfer is done, the web page is displayed on the screen of the receiving device.

### Scanning NFC tags

Your device can scan various kinds of NFC tags to receive additional information, such as a web address. For example, it can scan embedded tags on a poster, on a billboard advertisement, or beside a product in a retail store.

#### To scan an NFC tag

- 1 Make sure that your device has the NFC function turned on and that the screen is active and unlocked.
- 2 Place your device over the tag so that the NFC detection area touches it. Your device scans the tag and displays the content collected. Tap the content of the tag to open it.

### Connecting to an NFC compatible device

You can connect your device to other NFC compatible devices produced by Sony, such as a speaker or a headphone. When establishing this kind of connection, refer to the User guide of the compatible device for more information.

#### Note

You may need to have Wi-Fi or Bluetooth activated on both devices for the connection to work.

### Bluetooth wireless technology

Use the Bluetooth function to send files to other Bluetooth compatible devices, or to connect to handsfree accessories. Bluetooth connections work better within 10 metres (33 feet), with no solid objects in between. In some cases you have to manually pair your device with other Bluetooth devices.

**Note**

Interoperability and compatibility among Bluetooth devices can vary.

**Hint**

If you are using a device with multiple users, each user can change the Bluetooth settings, and the changes affect all users.

**To turn the Bluetooth function on or off**

- 1 Find and tap **Settings > Device connection > Bluetooth**.
- 2 Tap the **Bluetooth** switch to enable or disable the function.

**Hint**

You can also turn Bluetooth on or off from the Quick settings panel.

**Naming your device**

You can give your device a name. This name is shown to other devices after you have turned on the Bluetooth function and your device is set to visible.

**To give your device a name**

- 1 Make sure that the Bluetooth function is turned on.
- 2 Find and tap **Settings > Device connection > Bluetooth**.
- 3 Tap **Device name**.
- 4 Enter a name for your device.
- 5 Tap **RENAME**.

**Pairing with another Bluetooth device**

When you pair your device with another device, you can, for example, connect your device to a Bluetooth headset or a Bluetooth car kit, and use these other devices to share music.

Once you pair your device with another Bluetooth device, your device remembers this pairing.

**Note**

Some Bluetooth devices, for example, most Bluetooth headsets, require you to both pair and connect with the other device.

**Hint**

You can pair your device with several Bluetooth devices, but you can only connect to one Bluetooth profile at the same time.

**To pair your device with another Bluetooth device**

- 1 Make sure that the device you want to pair with has the Bluetooth function activated and is visible to other Bluetooth devices.
- 2 Find and tap **Settings > Device connection > Bluetooth**.
- 3 Tap the **Bluetooth** switch to enable the function. A list of the available Bluetooth devices appears.
- 4 Tap the Bluetooth device that you want to pair with.

**To connect your device to another Bluetooth device**

- 1 Find and tap **Settings > Device connection > Bluetooth**.
- 2 Tap the Bluetooth device that you want to connect to.

**To unpair a Bluetooth device**

- 1 Find and tap **Settings > Device connection > Bluetooth**.

- 2 Under **Paired devices**, tap  (Settings icon) beside the name of the device that you want to unpair.
- 3 Tap **Forget**.

## **Sending and receiving items using Bluetooth technology**

Use Bluetooth technology to share items with other Bluetooth compatible devices such as phones or computers. You can send and receive the following kinds of items:

- Photos and videos
- Music and other audio files
- Web pages

### **To send items using Bluetooth**

- 1 Make sure the Bluetooth function is turned on for the receiving device, and that the device is visible to other Bluetooth devices.
- 2 Open the application on the sending device which contains the item that you want to send. Scroll to the item.
- 3 Depending on the app and the item you want to send, you may need to touch and hold or open the item, then tap  (Share icon).
- 4 Select **Bluetooth**.
- 5 Turn on Bluetooth if prompted.
- 6 Tap the name of the receiving device.
- 7 On the receiving device, accept the connection if prompted.
- 8 On the sending device, confirm the transfer to the receiving device, if prompted.
- 9 Accept the incoming item on the receiving device.

### **To receive items using Bluetooth**

- 1 Make sure that the Bluetooth function is on and is visible to other Bluetooth devices.
- 2 The sending device now starts sending data to your device.
- 3 When you are notified of an incoming file to your device, drag the status bar downwards and tap the notification to accept the file transfer.
- 4 Tap **Accept** to start the file transfer.
- 5 To view the progress of the transfer, drag the status bar downwards.
- 6 To open a received item, drag the status bar downwards and tap the relevant notification.

### **To view files you have received using Bluetooth**

- 1 Find and tap **Settings > Device connection > Bluetooth**.
- 2 Tap **Show files received**.

# Smart apps and features that save you time

## Using your device as a wallet

You can use your device to pay for goods without reaching for your real wallet and manage all payment services in one place. When making a payment, remember to turn on the NFC function before you touch your device to a card reader. For more information about NFC, see *NFC (Near Field Communication)* on page 81.

### Note

Mobile payment services may not be available in your region. For Dual SIM devices, NFC-initiated payments are only supported for an NFC-enabled SIM card inserted in SIM card slot 1.

### To manage payment services

- 1 Make sure NFC is enabled on your device.
- 2 Find and tap **Settings > Apps & notifications > Advanced > Default Apps > Tap & pay**. A list of payment services appears.
- 3 Manage the payment services as desired. For example, you can change your default payment service.

# Clock and Calendar

## Calendar

Use the Calendar application to manage your time schedule.

If you have signed in to and synchronised your device with one or several online accounts that include calendars, for example, your Google account, then calendar events from these accounts will also appear in the Calendar application. You can select which calendars you want to integrate into the combined Calendar view.

When an appointment time approaches, your device plays a notification sound to remind you. Also,  (Calendar notification icon) appears in the status bar.

## Calendar overview

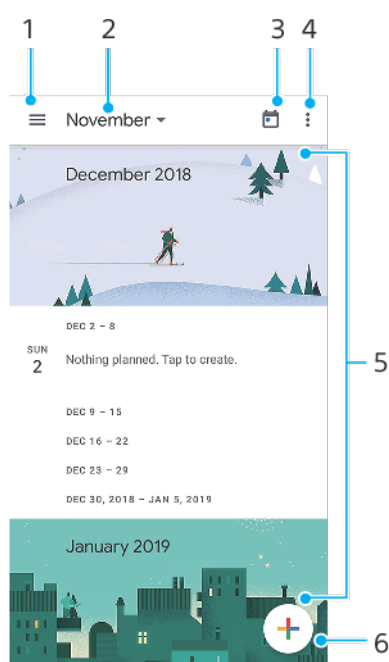

- 1 Access settings, select a view type and the calendars that you want to view
- 2 Access an overview of the current month
- 3 Return to the current date
- 4 View menu options
- 5 Scroll up or down to browse the calendar
- 6 Add a calendar entry

## Clock

You can set one or several alarms and use any sound file saved on your device as the alarm signal. The alarm does not sound if your device is turned off.

The alarm time format displayed is the same as the format you select for your general time settings, for example, 12-hour or 24-hour.

## Clock overview

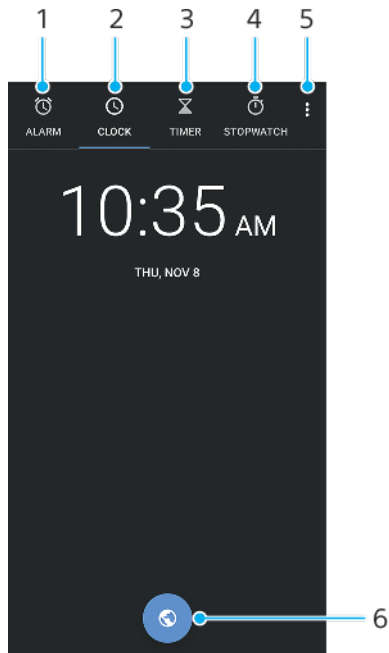

- 1 Access the Alarm tab
- 2 Access the Clock tab
- 3 Access the Timer tab
- 4 Access the Stopwatch tab
- 5 View menu options for the current tab
- 6 Add a world clock

### To set a new alarm

- 1 Find and tap **Clock > Alarm**.
- 2 Tap  (Add item icon).
- 3 Select the desired value.
- 4 Tap **OK**.

#### Hint

Tap  (More options icon) to edit the alarm.

### To snooze an alarm when it sounds

- When the alarm sounds, tap **SNOOZE**.

### To turn off an alarm when it sounds

- When the alarm sounds, tap **DISMISS**.

#### Hint

To turn off a snoozed alarm, you can drag down the status bar to open the Notification panel and then tap DISMISS.

### To edit an alarm time

- 1 Find and tap **Clock > Alarm**, then tap  (More options icon) for the alarm that you want to edit.
- 2 Tap the time and select the desired values, then tap **OK**.

### To turn an alarm on or off

- Find and tap **Clock > Alarm**, tap the switch.



### To delete an alarm

- Find and tap **Clock > Alarm**, then tap ∨ (More options icon) for the alarm that you want to delete, then tap **Delete**.

### To edit alarms

- 1 Find and tap **Clock > Alarm**.
- 2 Tap ☰ (Menu icon), then tap **Settings**.
- 3 Select and set the preferred option.

### To set the sound for an alarm

- 1 Find and tap **Clock > Alarm**, then tap ∨ (More options icon) for the alarm that you want to edit.
- 2 Tap 📣 (Alarm sound icon) and select an option, or tap **Add new** and select a music file.
- 3 Tap ◀ (Back button). The setting is saved.

### To set a recurring alarm

- 1 Find and tap **Clock > Alarm**, then tap ∨ (More options icon) for the alarm that you want to edit.
- 2 Tap the **Repeat** checkbox.
- 3 Mark the relevant days as desired.

### To set an alarm to vibrate

- 1 Find and tap **Clock > Alarm**, then tap ∨ (More options icon) for the alarm that you want to edit.
- 2 Tap the **Vibrate** checkbox.

### To set the Label for the alarm

- 1 Find and tap **Clock > Alarm**, then tap ∨ (More options icon) for the alarm that you want to edit.
- 2 Tap **Label**, then type a Label name.
- 3 Tap **OK**.

# Accessibility



## Magnification

Magnification allows you to zoom in to parts of the screen by tapping an area of the touchscreen three times in succession.

### To enable or disable Magnification

- 1 Find and tap **Settings** > **Accessibility** > **Magnification**.
- 2 Select an option and tap the switch to enable the function.

### To magnify an area and pan across the screen

- 1 Make sure that **Magnification** is enabled.
- 2 Depending on the selected magnification option, to temporarily magnify the area tap the screen three times or tap  (Magnification icon) first and then tap the screen.
- 3 Move the area by dragging it with two or more fingers.
- 4 To exit zoom mode, tap the area three times or tap  (Magnification icon) again.

#### Hint

With certain applications, you can also zoom in or out by pinching an area.

## Font size

You can enable the Font size option to increase the default size of text displayed on your device.

### To set Font size

- 1 Find and tap **Settings** > **Accessibility**.
- 2 Tap **Font size**, and then set the desired font size by tapping the scale.

## Display size

You can use the Display size setting to increase or decrease all elements on your screen, not just text.

### To set Display size

- 1 Find and tap **Settings** > **Accessibility**.
- 2 Tap **Display size**, and then set the desired display size by tapping the scale.

## Colour correction

The Colour correction setting adjusts how colours are displayed on the screen for users who are colour blind or have difficulty distinguishing between colours.

### To enable or disable Colour correction

- 1 Find and tap **Settings** > **Accessibility** > **Colour correction**.
- 2 Tap the switch under **Colour correction** to enable or disable the function.
- 3 Tap **Correction mode**, then select the appropriate colour sensitivity.

#### Note

Colour correction is currently an experimental feature and may affect device performance.

## Mono audio

The Mono audio setting makes both left and right audio channels get played back simultaneously when playing audio. Using Mono instead of Stereo playback is most useful for users with certain types of hearing loss or for safety reasons, for example when you need to listen to your surroundings.

### To enable or disable Mono audio

- 1 Find and tap **Settings > Accessibility**.
- 2 Tap the **Mono audio** switch to enable or disable this function.

# Support application

## About the Support app

Use the Support app to find device and software information. You can read support topics, troubleshoot, or use helpful applications such as the device test. Visit our Web support directly from the app to read User guides, knowledge articles, or the Support forum.

### Note

Support contact information is available from the Contact us menu even without a network connection.

### To access the Support app

- Find and tap **Settings** >  (Support icon).

### Hint

Connect to the internet when using the Support application for the best available support.

# Legal information

## General

This User guide is published by Sony Mobile Communications Inc. or its local affiliated company, without any warranty. Improvements and changes to this User guide necessitated by typographical errors, inaccuracies of current information, or improvements to programs and/or equipment, may be made by Sony Mobile Communications Inc. at any time and without notice. Such changes will, however, be incorporated into new editions of this User guide. All illustrations are for illustration purposes only and may not accurately depict the actual device.

All product and company names mentioned herein are the trademarks or registered trademarks of their respective owners. All other trademarks are property of their respective owners. Any rights not expressly granted herein are reserved. Visit [www.sonymobile.com/us/legal/](http://www.sonymobile.com/us/legal/) for more information.

This User guide may reference services or applications provided by third parties. Use of such programming or services may require separate registration with the third-party provider, payment of fees or provision of credit card information, as well as be subject to additional terms of use, change, interruption or discontinuance at any time. For applications accessed on or through a third-party website, please review such websites' terms of use and applicable privacy policy in advance. Sony does not warrant or guarantee the availability or performance of any third-party application, websites, or offered services.

Your device has the capability to download, store, and forward additional content, for example, ringtones. The use of such content may be restricted or prohibited by rights of third parties, including but not limited to restriction under applicable copyright laws. You, and not Sony, are entirely responsible for additional content that you download to or forward from your device. Prior to your use of any additional content, please verify that your intended use is properly licenced or is otherwise authorised. Sony does not guarantee the accuracy, integrity or quality of any additional content or any other third-party content. Under no circumstances will Sony be liable in any way for your improper use of additional content or other third-party content.

This product is licenced under the MPEG-4 visual and AVC patent portfolio licences for the personal and non-commercial use of a consumer for (i) encoding video in compliance with the MPEG-4 visual standard ("MPEG-4 video") or the AVC standard ("AVC video") and/or (ii) decoding MPEG-4 or AVC video that was encoded by a consumer engaged in a personal and non-commercial activity and/or was obtained from a video provider licenced by MPEG LA to provide MPEG-4 and/or AVC video. No licence is granted or shall be implied for any other use. Additional information including that relating to promotional, internal and commercial uses and licensing may be obtained from MPEG LA, L.L.C. See [www.mpegla.com](http://www.mpegla.com). MPEG Layer-3 audio decoding technology licenced from Fraunhofer IIS and Thomson.

**Note:** Sony Mobile advises users to backup their personal data and information.

SONY MOBILE WILL NOT BE LIABLE FOR ANY LOSS, DELETION AND/OR DATA-OVERWRITING OF PERSONAL DATA OR FILES STORED ON YOUR DEVICE (INCLUDING BUT NOT LIMITED TO CONTACTS, MUSIC TRACKS AND PICTURES) ARISING OUT OF ANY UPDATE OF YOUR DEVICE BY ANY OF THE METHODS DESCRIBED IN THIS USER GUIDE OR DOCUMENTATION. IN NO EVENT SHALL SONY MOBILE'S OR ITS SUPPLIERS' TOTAL LIABILITY TO YOU FOR ANY AND ALL DAMAGES, LOSSES AND CAUSES OF ACTION (WHETHER IN CONTRACT OR TORT, INCLUDING, BUT NOT LIMITED TO NEGLIGENCE OR OTHERWISE) EXCEED THE AMOUNT ACTUALLY PAID BY YOU FOR YOUR DEVICE.

©2019 Sony Mobile Communications Inc.

All rights reserved.

## Warranty, SAR, and usage guidelines

For information about warranty, SAR (Specific Absorption Rate), and safety guidelines, please read the Important information provided under Settings > System > About phone > Legal information on your device.