



alcatel 3

For more information on how to use the phone, please go to [www.alcatelmobile.com](http://www.alcatelmobile.com) and download the complete user manual. Moreover, on the website, you can also find answers to frequently asked questions, upgrade the software via Mobile Upgrade, and so much more.

## Note:

This is a user manual for Alcatel 3 5053D/5053Y/5053K.

## Help

Refer to the following resources to get more FAQ, software, and service information.

### Consulting FAQ

Go to

<https://www.alcatelmobile.com/content/faq/>

### Updating your phone's software

Update through the **Updates** app on your device.

To download the software update tool onto your PC, go to

<https://www.alcatelmobile.com/content/software-drivers/>

### Finding your serial number or IMEI

You can find your serial number or International Mobile Equipment Identity (IMEI) on the packaging materials. Or, on the phone, choose **Settings > System > About phone > Status**.

### Obtaining warranty service

First follow the advice in this guide. Then check hotlines and repair centres information through

<https://www.alcatelmobile.com/content/hotline-service-center/>

### Viewing legal information

On the phone, go to **Settings > System > About phone > Legal information**.

### Using other alcatel apps

Go to

<https://www.alcatelmobile.com/content/app-services/>

# Table of Contents

Safety and use .....	6
Radio waves .....	15
Licences.....	20
General information.....	22
<b>1 Your mobile.....</b>	<b>26</b>
1.1 Keys and connectors.....	26
1.2 Getting started.....	29
1.3 Home screen.....	32
<b>2 Text input .....</b>	<b>42</b>
2.1 Using the onscreen keyboard .....	42
2.2 Text editing.....	44
<b>3 Phone, Call logs and Contacts.....</b>	<b>45</b>
3.1 Phone .....	45
3.2 Call logs.....	51
3.3 Contacts.....	52
<b>4 Messages.....</b>	<b>60</b>
4.1 Write a new message .....	60
4.2 Manage messages.....	62
<b>5 Calendar, Clock, and Calculator.....</b>	<b>63</b>
5.1 Calendar.....	63
5.2 Clock.....	65

5.3	Calculator.....	68
<b>6</b>	<b>Getting connected .....</b>	<b>69</b>
6.1	Connecting to the internet.....	69
6.2	Connecting to a Bluetooth device.....	72
6.3	Connecting to a computer via USB.....	73
6.4	Sharing your phone's mobile data connection.....	74
6.5	Connecting to virtual private networks ...	75
<b>7</b>	<b>Multimedia applications .....</b>	<b>77</b>
7.1	Camera.....	77
7.2	Gallery.....	81
<b>8</b>	<b>Others .....</b>	<b>85</b>
8.1	Radio.....	85
8.2	Support Centre.....	88
8.3	Other applications.....	88
<b>9</b>	<b>Google applications .....</b>	<b>89</b>
9.1	Chrome.....	89
9.2	Gmail.....	89
9.3	Maps.....	90
9.4	YouTube.....	90
9.5	Play Store.....	90
9.6	Play Music .....	91
<b>10</b>	<b>Settings.....</b>	<b>92</b>
10.1	Network & connection.....	92

10.2	Display.....	95
10.3	Security & location.....	95
10.4	Advanced Features.....	95
10.5	Apps.....	95
10.6	Smart Manager.....	96
10.7	Sound.....	96
10.8	Accounts .....	96
10.9	Google.....	96
10.10	Accessibility .....	97
10.11	System.....	97
<b>11</b>	<b>Making the most of your phone .....</b>	<b>100</b>
11.1	FOTA Upgrade.....	100
<b>12</b>	<b>Accessories .....</b>	<b>101</b>
<b>13</b>	<b>Warranty.....</b>	<b>102</b>
<b>14</b>	<b>Troubleshooting.....</b>	<b>105</b>
<b>15</b>	<b>Specifications .....</b>	<b>114</b>



www.sar-tick.com  
alcatel

This product meets applicable national SAR limits of 2.0 W/kg. The specific maximum SAR values can be found on **Radio waves** section.

When carrying the product or using it while worn on your body, either use an approved accessory such as a holster or otherwise maintain a distance of 5 mm from the body to ensure compliance with RF exposure requirements. Note that the product may be transmitting even if you are not making a phone call.



### PROTECT YOUR HEARING

To prevent possible hearing damage, do not listen at high volume levels for long periods. Exercise caution when holding your device near your ear while the loudspeaker is in use.

## Safety and use .....

We recommend that you read this chapter carefully before using your phone. The manufacturer disclaims any liability for damage, which may result as a consequence of improper use or use contrary to the instructions contained herein.

### • TRAFFIC SAFETY:

Given that studies show that using a phone while driving a vehicle constitutes a real risk, even when the hands-free kit is used (car kit, headset...), drivers are requested to refrain from using their phone when the vehicle is not parked.

When driving, do not use your phone and headset to listen to music or to the radio. Using a headset can be dangerous and forbidden in some areas.

When switched on, your phone emits electromagnetic waves that can interfere with the vehicle's electronic systems such as ABS anti-lock brakes or airbags. To ensure that there is no problem:

- Do not place your phone on top of the dashboard or within an airbag deployment area;
- Check with your car dealer or the car manufacturer to make sure that the dashboard is adequately shielded from phone RF energy.

## ● CONDITIONS OF USE:

You are advised to switch off the phone from time to time to optimise its performance.

Switch the phone off before boarding an aircraft.

Switch the phone off when you are in health care facilities, except in designated areas. As with many other types of equipment now in regular use, phones can interfere with other electrical or electronic devices, or equipment using radio frequency.

Switch the phone off when you are near gas or flammable liquids. Strictly obey all signs and instructions posted in a fuel depot, petrol station, or chemical plant, or in any potentially explosive atmosphere.

When the phone is switched on, it should be kept at least 15 cm from any medical device such as a pacemaker, a hearing aid, or an insulin pump, etc.. In particular when using the phone, you should hold it against the ear on the opposite side to the device, if any.

To avoid hearing impairment, pick up the call before holding your phone to your ear. Also move the phone away from your ear while using the "hands-free" mode because the amplified volume might cause hearing damage.

Do not let children use the phone and/or play with the phone and accessories without supervision.

If your phone has a removable cover, note that your phone may contain substances that could create an allergic reaction.

If your phone is a unibody device, the back cover and battery are not removable. If you disassemble your phone the warranty will not apply. Disassembling the phone may damage the battery, and may cause leakage of substances that could create an allergic reaction.

Always handle your phone with care and keep it in a clean and dust-free place.

Do not allow your phone to be exposed to adverse weather or environmental conditions (moisture, humidity, rain, infiltration of liquids, dust, sea air, etc.). The manufacturer's recommended operating temperature range is 0°C (32°F) to +40°C (104°F).

At over 40°C (104°F) the legibility of the phone's display may be impaired, though this is temporary and not serious.

Do not open, dismantle, or attempt to repair your phone yourself.

Do not drop, throw, or bend your phone.

Do not use the phone if the glass screen is damaged, cracked, or broken to avoid any injury.

Do not paint it.

Use only batteries, battery chargers, and accessories which are recommended by TCL Communication Ltd. and its affiliates and are compatible with your phone model. TCL Communication Ltd. and its affiliates disclaim any liability for damage caused by the use of other chargers or batteries.

Remember to make backup copies or keep a written record of all important information stored on your phone.

Some people may suffer epileptic seizures or blackouts when exposed to flashing lights, or when playing video games. These seizures or blackouts may occur even if a person never had a previous seizure or blackout. If you have experienced seizures or blackouts, or if you have a family history of such occurrences, please consult your doctor before playing video games on your phone or enabling a flashing-lights feature on your phone.

Parents should monitor their children's use of video games or other features that incorporate flashing lights on the phones. All persons should discontinue use and consult a doctor if any of the following symptoms occur: convulsion, eye or muscle twitching, loss of awareness, involuntary movements, or disorientation. To limit the likelihood of such symptoms, please take the following safety precautions:

- Do not play or use a flashing-lights feature if you are tired or need sleep;

- Take a minimum of a 15-minute break hourly;
- Play in a room in which all lights are on;
- Play at the farthest distance possible from the screen;
- If your hands, wrists, or arms become tired or sore while playing, stop and rest for several hours before playing again;
- If you continue to have sore hands, wrists, or arms during or after playing, stop the game and see a doctor.

When you play games on your phone, you may experience occasional discomfort in your hands, arms, shoulders, neck, or other parts of your body. Follow the instructions to avoid problems such as tendinitis, carpal tunnel syndrome, or other musculoskeletal disorders.

## ● **PRIVACY:**

Please note that you must respect the laws and regulations in force in your jurisdiction or other jurisdiction(s) where you will use your phone regarding taking photographs and recording sounds with your phone. Pursuant to such laws and regulations, it may be strictly forbidden to take photographs and/or to record the voices of other people or any of their personal attributes, and reproduce or distribute them, as this may be considered to be an invasion of privacy. It is the user's sole responsibility to ensure that prior authorisation has been obtained, if necessary, in order to record private or confidential conversations or take a photograph of another person; the manufacturer, the seller or vendor of your phone (including the operator) disclaim any liability which may result from improper use of the phone.

## ● **BATTERY:**

Following air regulation, the battery of your product is not charged. Please charge it first.

### **For a non-unibody device:**

Observe the following precautions:

- Do not attempt to open the battery (due to the risk of toxic fumes and burns);
- Do not puncture, disassemble, or cause a short circuit in a battery;

- Do not burn or dispose of a used battery in household rubbish or store it at temperatures above 60°C (140°F).

Batteries must be disposed of in accordance with locally applicable environmental regulations. Only use the battery for the purpose for which it was designed. Never use damaged batteries or those not recommended by TCL Communication Ltd. and/or its affiliates.

### **For a non-unibody device with a non-removable battery:**

Observe the following precautions:

- Do not attempt to eject, replace or open the battery;
- Do not puncture, disassemble, or cause a short circuit in the battery;
- Do not burn or dispose of your phone in household rubbish or store it at temperature above 60°C (140°F).

Phone and battery must be disposed of in accordance with locally applicable environmental regulations.

### **For a unibody device:**

Observe the following precautions:

- Do not attempt to open the back cover;
- Do not attempt to eject, replace, or open battery;
- Do not puncture the back cover of your phone;

- Do not burn or dispose of your phone in household rubbish or store it at temperature above 60°C (140°F).

Phone and battery as a unibody device must be disposed of in accordance with locally applicable environmental regulations.



This symbol on your phone, the battery, and the accessories means that these products must be taken to collection points at the end of their life:

- Municipal waste disposal centres with specific bins for these items of equipment;
- Collection bins at points of sale.

They will then be recycled, preventing substances being disposed of in the environment, so that their components can be reused.

#### **In European Union countries:**

These collection points are accessible free of charge.

All products with this sign must be brought to these collection points.

#### **In non-European Union jurisdictions:**

Items of equipment with this symbol are not to be thrown into ordinary bins if your jurisdiction or your region has suitable recycling and collection facilities; instead they are to be taken to collection points for them to be recycled.

**CAUTION:** RISK OF EXPLOSION IF BATTERY IS REPLACED BY AN INCORRECT TYPE. DISPOSE OF USED BATTERIES ACCORDING TO THE INSTRUCTIONS.

#### **● CHARGERS:**

Mains powered chargers will operate within the temperature range of: 0°C (32°F) to 40°C (104°F).

The chargers designed for your phone meet the standard for safety of information technology equipment and office equipment use. They are also compliant with the ecodesign directive 2009/125/EC. Due to different applicable electrical specifications, a charger you purchased in one jurisdiction may not work in another jurisdiction. They should be used for this purpose only.

This device is compatible with the charger, which complies with the following standards relating to the Common Mobile Phone Charger:

- EN301 489-34 V2.1.1 Final Draft (2017-04)
- EN 62684:2018



## Radio waves .....

Proof of compliance with international standards (ICNIRP) or with European Directive 2014/53/EU (RED) is required of all phone models before they can be put on the market. The protection of the health and safety for the user and any other person is an essential requirement of these standards or this directive.

**THIS DEVICE MEETS INTERNATIONAL GUIDELINES FOR EXPOSURE TO RADIO WAVES.**

Your phone is a radio transmitter and receiver. It is designed not to exceed the limits for exposure to radio waves (radio frequency electromagnetic fields) recommended by international guidelines. The guidelines were developed by an independent scientific organisation (ICNIRP) and include a substantial safety margin designed to assure the safety of all persons, regardless of age and health.

The radio wave exposure guidelines use a unit of measurement known as the Specific Absorption Rate, or SAR. The SAR limit for mobile devices is 2 W/kg.

Tests for SAR are conducted using standard operating positions with the device transmitting at its highest certified power level in all tested frequency bands. The highest SAR values under the ICNIRP guidelines for this device model are:

5053D

Maximum SAR for this model and conditions under which it was recorded		
Head SAR	GSM 900 + WLAN 2.4G	0.67 W/kg
Body-worn SAR	GSM 1800 + WLAN 2.4G	1.62 W/kg

5053Y/5053K

Maximum SAR for this model and conditions under which it was recorded		
Head SAR	UMTS 900 + WLAN 2.4G	0.61 W/kg
Body-worn SAR	LTE Band 7 + WLAN 2.4G	1.70 W/kg

During use, the actual SAR values for this phone are usually well below the values stated above. This is because, for purposes of system efficiency and to minimise interference on the network, the operating power of your phone is automatically decreased when full power is not needed for the call. The lower the power output of the phone, the lower its SAR value.

Body-worn SAR testing has been carried out at a separation distance of 5 mm. To meet RF exposure guidelines during body-worn operation, the phone should be positioned at least this distance away from the body.

If you are not using an approved accessory ensure that whatever product is used is free of any metal and that it positions the phone the indicated distance away from the body.

Organisations such as the World Health Organisation and the US Food and Drug Administration have stated that if people are concerned and want to reduce their exposure they could use a hands-free device to keep the phone away from the head and body during phone calls, or reduce the amount of time spent on the phone.

For more information, you can go to [www.alcatelmobile.com](http://www.alcatelmobile.com).

Additional information about electromagnetic fields and public health are available on the following site: <http://www.who.int/peh-emf>.

Your phone is equipped with a built-in antenna. For optimal operation, you should avoid touching it or degrading it.

As mobile devices offer a range of functions, they can be used in positions other than against your ear. In such circumstances the phone will be compliant with the guidelines when used with a headset or USB data cable. If you are using another accessory ensure that whatever product is used is free of any metal and that it positions the phone at least 5 mm away from the body.

Please note by using the device some of your personal data may be shared with the main device. It is under your own responsibility to protect your own personal data, not to share with it with any unauthorised devices or third party devices connected to yours. For products with Wi-Fi features, only connect to trusted Wi-Fi networks. Also when using your product as a hotspot (where available), ensure your network security. These precautions will help prevent unauthorised access to your phone. Your product can store personal information in various locations including a SIM card, memory card, and built-in memory. Be sure to remove or clear all personal information before you recycle, return, or give away your product. Choose your apps and updates carefully, and install from trusted sources only. Some apps can impact your product's performance and/or have access to private information including account details, call data, location details, and network resources.

Note that any data shared with TCL Communication Ltd. is stored in accordance with applicable data protection legislation. For these purposes TCL Communication Ltd. implements and maintains appropriate technical and organisational measures to protect all personal data, for example, against unauthorised or unlawful processing and accidental loss or destruction of or damage to such personal data whereby the measures shall provide a level of security that is appropriate having regard to

- The technical possibilities available;
- The costs for implementing the measures;
- The risks involved with the processing of the personal data, and;
- The sensitivity of the personal data processed.

You can access, review, and edit your personal information at any time by logging into your user account, visiting your user profile or by contacting us directly. Should you require us to edit or delete your personal data, we may ask you to provide us with evidence of your identity before we can act on your request.

## Licences.....



microSD logo is a trademark.



The Bluetooth word mark and logos are owned by the Bluetooth SIG, Inc. and any use of such marks by TCL Communication Ltd. and its affiliates is under licence. Other trademarks and trade names are those of their respective owners.

**Alcatel 5053D/5053Y/5053K** Bluetooth Declaration ID D043602



The Wi-Fi Logo is a certification mark of the Wi-Fi Alliance.

This equipment may be operated in all European countries.

This device may be operated without restrictions in any EU member state.

Google, the Google logo, Android, the Android logo, Google Search™, Google Maps™, Gmail™, YouTube, Google Play Store, Google Latitude™, and Hangouts™ are trademarks of Google Inc.

The Android robot is reproduced or modified from work created and shared by Google and used according to terms described in the Creative Commons 3.0 Attribution License (the text will show when you touch **Google legal in Settings > System > About phone > Legal information**) <sup>(1)</sup>.

You have purchased a product which uses the open source (<http://opensource.org/>) programmes mtd, msdosfs, netfilter/iptables and initrd in object code and other open source programmes licensed under the GNU General Public Licence and Apache Licence.

We will provide you with a complete copy of the corresponding source codes upon request within a period of three years from the distribution of the product by TCL Communication Ltd.

You may download the source codes from <http://sourceforge.net/projects/alcatel/files/>. The provision of the source code is free of charge from the internet.

We hereby point out that the end user warranty for infringement IPR is solely limited to the EU/EEA/Switzerland.

<sup>(1)</sup> May not be available in all countries.

If and to the extent that the Product is exported, taken with, or used by end customer or end user outside the EU/EEA/Switzerland any responsibility, warranty or indemnification of manufacturer and its suppliers in regard to the Product expires (including any indemnification in regard to infringement IPR).

## General information.....

- **Internet address:** [www.alcatelmobile.com](http://www.alcatelmobile.com)
- **Hotline:** See the "SERVICES" leaflet that came with your phone or go to our website.
- **Manufacturer:** TCL Communication Ltd.
- **Address:** 5/F, Building 22E, 22 Science Park East Avenue, Hong Kong Science Park, Shatin, NT, Hong Kong
- **Electronic labeling path:** Touch **Settings > System > Regulatory & safety** or press \*#07#, you can find more information about labelling <sup>(1)</sup>.

On our website, you will find our FAQ (Frequently Asked Questions) section. You can also contact us by email to ask any questions you may have.

This radio equipment operates with the following frequency bands and maximum radio-frequency power:  
GSM 850/900: 33 dBm

<sup>(1)</sup> It depends on countries.

GSM 1800/1900: 30 dBm

UMTS B1/2/5/8 (2100/1900/850/900): 24 dBm

LTE 1/3/7/8/20/28 (2100/1800/2600/900/800/700):  
24 dBm

Bluetooth 2.4GHz band: 10.59 dBm

Bluetooth LE: 1.53dBm

802.11 b/g/n 2.4GHz band: 15.43 dBm;

NFC 13.56 MHz: -16.96 dBuA/m at 10m <sup>(1)</sup>

- **Regulatory information**

Hereby, TCL Communication Ltd. declares that the radio equipment type **Alcatel 5053D/5053Y/5053K** is in compliance with Directive 2014/53/EU.

The full text of the EU declaration of conformity is available at the following internet address: [http://www.alcatelmobile.com/EU\\_doc](http://www.alcatelmobile.com/EU_doc).

- **Additional information**

The description of accessories and components, including software, which allow the radio equipment to operate as intended, can be obtained in the full text of the EU declaration of conformity at the following internet address: [http://www.alcatelmobile.com/EU\\_doc](http://www.alcatelmobile.com/EU_doc).

<sup>(1)</sup> 5053Y/5053K only.

## **Protection against theft <sup>(1)</sup>**

Your phone is identified by an IMEI (phone serial number) shown on the packaging label and in the phone's memory. We recommend that you note the number the first time you use your phone by entering \*#06# and keep it in a safe place. It may be requested by the police or your operator if your phone is stolen. This number allows your phone to be blocked preventing a third person from using it, even with a different SIM card.

## **Disclaimer**

There may be certain differences between the user manual description and the phone's operation, depending on the software release of your phone or specific operator services.

TCL Communication Ltd. shall not be held legally responsible for such differences, if any, nor for their potential consequences, which responsibility shall be borne by the operator exclusively. This phone may contain materials, including applications and software in executable or source code form, which is submitted by third parties for inclusion in this phone ("Third Party Materials"). All Third Party Materials in this phone are provided "as is", without warranty of any kind, whether express or implied. The purchaser undertakes

<sup>(1)</sup> Contact your network operator to check service availability.

that TCL Communication Ltd. has complied with all quality obligations incumbent upon it as a manufacturer of mobile devices and phones in complying with Intellectual Property rights. TCL Communication Ltd. will at no stage be responsible for the inability or failure of the Third Party Materials to operate on this phone or in interaction with any other device. To the maximum extent permitted by law, TCL Communication Ltd. disclaims all liability for any claims, demands, suits or actions, and more specifically – but not limited to – tort law actions, under any theory of liability, arising out of the use, by whatever means, or attempts to use, such Third Party Materials. Moreover, the present Third Party Materials, which are provided free of charge by TCL Communication Ltd., may be subject to paid updates and upgrades in the future; TCL Communication Ltd. waives any responsibility regarding such additional costs, which shall be borne exclusively by the purchaser. TCL Communication Ltd. shall not be held responsible for the lack of availability of any application, as its availability depends on the country and the operator of the purchaser. TCL Communication Ltd. reserves the right at any time to add or remove Third Party Materials from its phones without prior notice; in no event shall TCL Communication Ltd. be held responsible by the purchaser for any consequences of such removal.

# 1 Your mobile .....

## 1.1 Keys and connectors



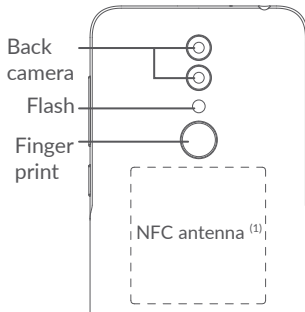

### Back button

- Touch to go back to the previous screen, or close a dialog box, options menu, the Notification panel, etc.



### Home button

- From any application or screen, touch to return to the Home screen.
- Long press to turn on Google Now. You can get help such as getting directions and restaurant information based on the content detected on the screen.



### Recent Apps button

- Touch to open a card view of applications you've worked with recently.



### Power key

- Press: Lock the screen/Light up the screen.
- Press and hold: Show the popup menu to select from **Restart/Power off/Aeroplane mode**.
- Press and hold the **Power** key and **Volume down** key to take a screenshot.
- Press and hold the **Power** key for at least 10 seconds to force reboot.



### Volume keys

- In call mode, adjusts the call volume.
- In Music/Video/Streaming mode, adjusts the media volume.
- In general mode, adjusts the ringtone volume.
- Mutes the ringtone of an incoming call.
- In camera preview mode, press **Volume up** or **down** key to take a photo or press and hold to take a burst shot.

<sup>(1)</sup> 5053Y/5053K only.

## 1.2 Getting started

### 1.2.1 Setting up

- 1 Insert the pin into the hole and pull out the tray.
- 2 Insert or remove your SIM card or microSD card.

#### Single-SIM



#### Dual SIM



-  Your phone only supports nano-SIM cards. Do not attempt to insert other SIM types like mini and micro cards; otherwise this may cause damage to your phone.



## Charging the battery

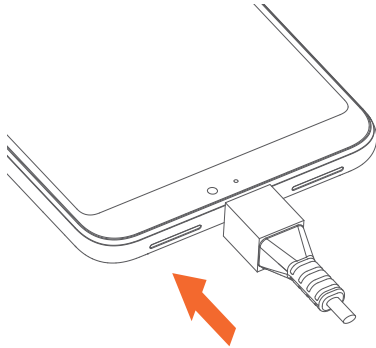

You are advised to fully charge the battery (🔋). Charging status is indicated by a percentage displayed on screen. The percentage increases as the phone is charged.



To reduce power consumption and energy waste when the battery is fully charged, disconnect your charger from the plug; switch off Wi-Fi, GPS, Bluetooth or background-running applications when not in use; reduce the backlight time, etc.

### 1.2.2 Powering on your phone

Hold down the **Power** key until the phone powers on, unlock your phone (Swipe, PIN, Password or Pattern) if necessary and confirm. The Home screen is displayed.

If you do not know your PIN code or forget it, contact your network operator. Be sure to keep your PIN code safe.

### 1.2.3 Powering off your phone

Press and hold the **Power** key until options appear, then select **Power off**.

## 1.3 Home screen

You can bring all the items (applications, shortcuts, folders and widgets) you love or use most frequently to your Home screen for quick access. Touch the **Home** button to switch to the Home screen.

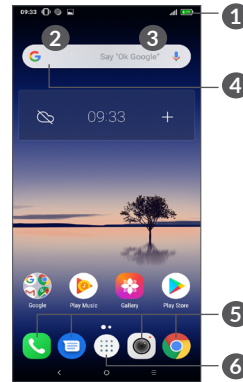

## 1 Status bar

- Status/Notification indicators
- Touch left and drag down to open the Notification panel.

## 4 Google Search bar

- Touch 2 to enter text search screen
- Touch 3 to enter voice search screen

## 5 Favourites tray applications

- Enter the application.
- Long press to move or remove applications.

## 6 Enter the App drawer

### Reversible screen

The phone supports the reversible function. From the app list, touch **Settings > Display > Auto-rotate screen** to enable the function.

### 1.3.1 Using the touchscreen

#### Touch



To access an application, touch it with your finger.

#### Long press



To enter the available options for an item, long press the item. For example, select a contact in Contacts, long press this contact, an option list will appear.

#### Drag



Long press an item and drag it to another location.

#### Slide/Swipe



Slide the screen to scroll up and down the applications, images, and web pages. You can slide the screen horizontally too.

#### Flick



Similar to swiping, flicking is a lighter and quicker stroke.

#### Pinch/Spread



Place two fingers on the screen surface and draw them apart or together to scale an element on the screen.

The phone also supports one finger zooming in **Gallery**. Double touch the screen to zoom in/out.

## Rotate



Automatically change the screen orientation from portrait to landscape by turning the phone sideways to have a better screen view.

### 1.3.2 Status bar

From the Status bar, you can view both phone status (on the right side) and notification information (on the left side).

Touch and drag up to close Notification panel or Quick Settings panel. When there are notifications, you can touch them to access notifications.

## Notification panel

When there are notifications, touch left and drag down the Status bar to open the Notification panel to read more detailed information.

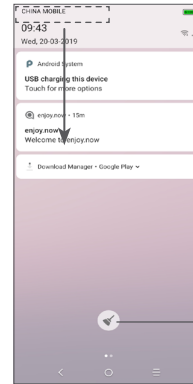

Clear all notifications  
(ongoing notifications  
will remain)

## Quick Settings panel

Touch right and drag down the Status bar to open the Quick Settings panel. You can enable or disable functions or change modes by touching the icons.

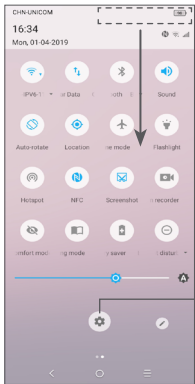

Open **Settings**, to view the full list of settings.

### 1.3.3 Locking and unlocking your screen

To protect your phone and privacy, you can lock the phone with a pattern, PIN, password or fingerprint, etc.

#### To create a screen unlock pattern

- From the app list, touch **Settings > Security & location > Screen lock**.
- Set your own pattern.

#### To lock phone screen

Press the **Power** key once to lock the screen.

### To unlock the phone screen

Press the **Power** key once to light up the screen, slide to draw the unlock pattern you have created or enter your PIN, password or fingerprint, etc.

If you have chosen **Swipe** as the screen lock, you can press the **Power** key to light up the screen, then swipe up to unlock the screen.

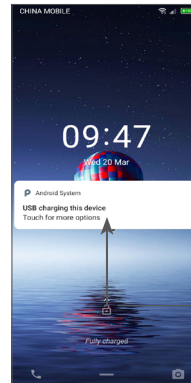

Swipe up to unlock the screen

### 1.3.4 Personalising your Home screen

#### Add

You can long press a folder, an application or a widget and drag the item to your preferred Home screen.

## Reposition

Long press an item and drag it to the desired position and then release. You can move items both on the Home screen and the Favourites tray. Hold the icon on the left or right edge of the screen to drag the item to another Home screen.

## Remove

Long press an item and drag it up to the top of the **Remove** icon, then release.

## Create folders

To improve the organisation of shortcuts or applications on the Home screen and the Favourites tray, you can add them to a folder by stacking one item on top of another. To rename a folder, open it and touch the folder's title bar to input the new name.

## Wallpaper customisation

Long press an empty area on the Home screen, then touch **WALLPAPERS** to customise wallpaper.

### 1.3.5 Widgets and recently used applications

#### Consult widgets

Long press the empty area on the Home screen, then touch **WIDGETS** to display all widgets.

Touch the selected widget and slide it to move to your preferred screen.

#### Consult recently used applications

To consult recently used applications, touch the **Recent Apps** button. Touch a thumbnail in the window to open the application.

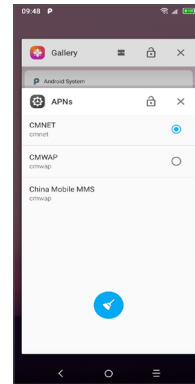



Touch one thumbnail and slide it right/left or touch **X** to close an application.

Touch  at the bottom of the screen to close all the running applications.

### 1.3.6 Volume adjustment

#### Using the volume key

Press the **Volume** key to adjust the volume. To activate the vibrate mode, press the **Volume down** key until the phone vibrates, or touch  to show this icon .

#### Using the settings menu

From the app list, touch **Settings** > **Sound** to set the volume for media, ringtones, alarms, etc.

## 2 Text input.....

### 2.1 Using the onscreen keyboard

#### Onscreen keyboard settings

Go to **Settings** > **System** > **Languages & input** > **Virtual keyboard**, touch the keyboard you want to set up and a series of settings will become available.

#### Adjust the onscreen keyboard orientation

Turn the phone sideways or upright to adjust the onscreen keyboard orientation. You can adjust it by changing the settings (**Touch Settings** > **Display** > **Auto-rotate screen**).

## 2.1.1 Gboard

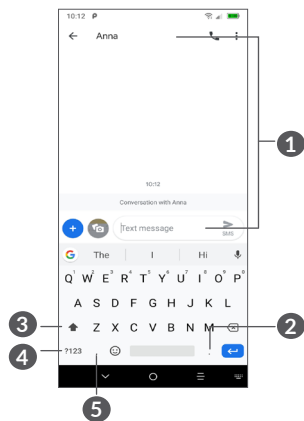

- 1 Enter text or numbers.
- 2 Long press to select symbols.
- 3 Switch between "abc/Abc" mode; Long press to switch to "abc/ABC" mode.
- 4 Switch to symbol and numeric keyboard.
- 5 Long press to show input options.

## 2.2 Text editing

You can edit the texts you entered.

- Long press or double tap within the texts you want to edit.
- Drag the tabs to change the selected texts.
- The following options will show: **CUT**, **COPY**, **SHARE** and **SELECT ALL**.

You can also insert new texts if preferred

- Touch where you want to type, or long press a blank space, the cursor will blink and the tab will show. Drag the tab to move the cursor.
- If you have cut or copied any text, touch the tab to show **PASTE** which allows you to paste any text you have previously copied.

# 3 Phone, Call logs and Contacts.....

## 3.1 Phone .....

### 3.1.1 Making a call

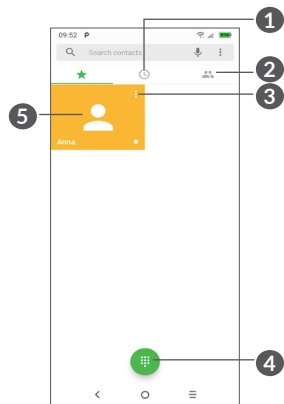

To make a call, touch  in the Favourites tray.



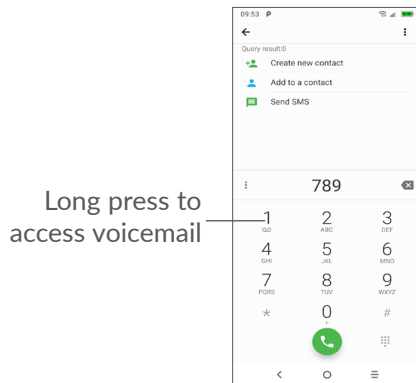

- 1 Call logs
- 2 Contacts

- 3 View the contact's detailed information. You can also edit, delete, share the contact, or send a message to the contact.
- 4 Show the dial pad
- 5 Call the previewed number.



Enter the desired number from the dial pad and touch  to place the call or select a contact from **Contacts** or **Call logs** by sliding or touching tabs, then touch  to make the call.

The number you entered can be saved to **Contacts** by touching the **Create new contact** icon  or the **Add to a contact** icon .



If you make a mistake, you can delete the incorrect digits by touching .

To hang up a call, touch .

### International call

To dial an international call, long press 0 to enter “+”, then enter the international country prefix followed by the full phone number and touch .

### Emergency call



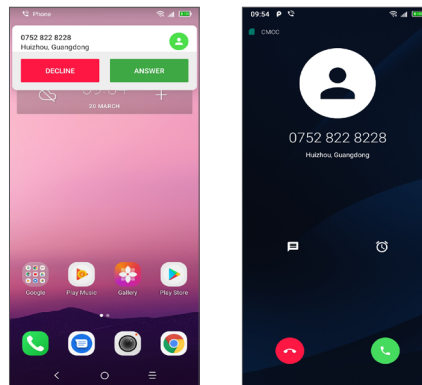

If your phone has network coverage, dial the emergency number and touch  to make an emergency call. This works even without a SIM card and without typing the PIN code.

## 3.1.2 Answering or rejecting a call



When you receive a call, a call window will be presented on top of the screen. Touch **DECLINE** to dismiss a call or **ANSWER** to answer a call. Touch the call window to open the Phone call screen.

On the Phone call screen:

- Touch  to answer the call;
- Touch  to reject the call;
- Touch  to reject the call by sending a preset message.
- Touch  to set a call back reminder.

### 3.1.3 Calling your voicemail

Your voicemail is provided by your network to avoid missing calls. It works like an answering machine that you can consult at any time.

To access your voicemail, long press .

If you receive a voicemail,  appears on the Status bar. Open the Notification panel and touch **New voicemail**.

### 3.1.4 During a call

To adjust the volume during a call, press the **Volume** key.

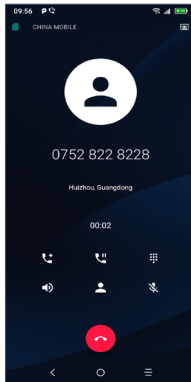



 End the current call.

 Touch once to activate the speaker during the current call. Touch this icon again to deactivate the speaker.

 Touch once to mute the current call. Touch this icon again to unmute the call.

 Display the dial pad.

 Touch once to hold the current call. Touch this icon again to retrieve the call.

 Touch to add another call.

 Touch to open **Contacts** options.

 To avoid accidental operation of the touchscreen during a call, the screen will be locked automatically when you put the phone close to your ear; and it will be unlocked when the phone is taken away from your ear.

### 3.1.5 Managing multiple calls





With this phone you can handle multiple calls at the same time.

#### Swap calls

When you accept two calls, touch the contact photo or  to switch between two lines. The current call will be put on hold and you are able to join the other call.

## Conference calls <sup>(1)</sup>

You can set up a conference call as follows.

- Place a call to the first participant of the conference call.
- Touch  to add another call.
- Enter the phone number of the person you want to add to conference and touch . You can also add participants from **Call logs** or **Contacts**.
- Touch  to start the conference.
- Touch  to end the conference call and disconnect all callers.

### 3.1.6 Phone settings

Touch  from the **Phone** screen, then touch **Settings** to set phone and contacts.

## 3.2 Call logs

You can access your call logs by touching  from the **Phone** screen to view missed calls, outgoing calls and incoming calls.

Touch  to view information or further operations, you can launch a new call, send a message to the contact or number, view detailed information of the call, or clear the call.

<sup>(1)</sup> Depending on your network operator.

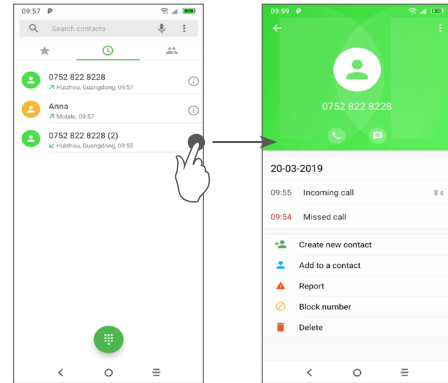

Touch  to **Delete all history**.

## 3.3 Contacts.....

**Contacts** enables quick and easy access to the contact you want to reach.

You can view and create contacts on your phone and synchronise them with your Gmail contacts or other applications on the web or on your phone.

### 3.3.1 Consult your Contacts

To see your contacts, touch  from the App drawer.

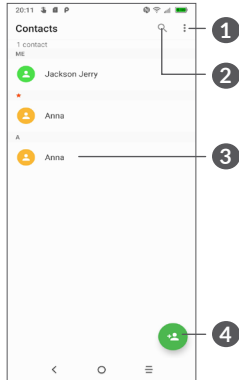

- 1 Display the contacts list option menu
- 2 Touch to search contacts
- 3 Open the Quick contact panel  
Long press to select contact(s) to delete
- 4 Add new contact

 Deleted contacts will also be removed from other applications on the phone or web the next time you synchronise your phone.

### 3.3.2 Adding a contact

Touch  in the contact list to create a new contact.

You are required to enter the contact's name and other contact information. By scrolling up and down the screen, you can move from one field to another.

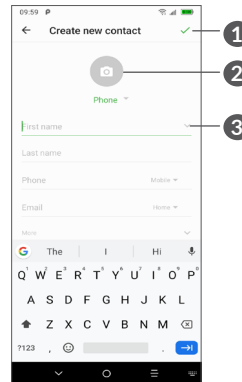

- 1 When finished, touch this icon to save
- 2 Select a picture or take a photo for the contact
- 3 Touch to open available labels

### Add to/Remove from favourites <sup>(1)</sup>

To add a contact to favourites, you can touch a contact to view details then touch ☆ to add the contact to favourites.

To remove a contact from favourites, touch the star ★ on the contact details screen.

### 3.3.3 Editing your contacts

To edit contact information, touch ✎ in the contact details screen.

When finished, touch ✓ to save.

<sup>(1)</sup> Only phone contacts and account contacts can be added to favourites.

### 3.3.4 Use Quick contact for Android

Touch a contact to open Quick contact panel for Android. You can then touch ☎ or the number to make a call. To send a message, touch 💬.

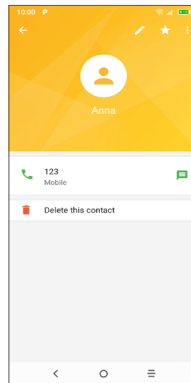

The icons available on the Quick contact panel depend on the information you have for the contact and the applications and accounts on your phone.

### 3.3.5 Importing, exporting and sharing contacts

This phone enables you to import or export contacts between your phone, SIM card and phone storage.

From the Contacts screen, touch  to open the options menu. Touch **Settings > Import/Export**, then select to import/export contacts from/to your accounts, SIM card, Phone, internal storage, micro SD card, etc.

You can share a single contact or contacts with others by sending the contact's vCard to them via Bluetooth, Gmail, etc.

Touch the contact you want to share, touch  and **Share** from the contact details screen. And then select the application to perform this action.

### 3.3.6 Displaying contacts

You can configure which list of contacts, for each account, you want to display in the Contacts list. Touch  and touch **Contacts to display** from contacts list screen, then you can choose which contacts to display.

Touch  and then **Settings > Display options** to sort the list by touching **First name** or **Last name**, as well as viewing contact names by touching **First name first** or **Last name first**.

### 3.3.7 Merging/Separating contacts

To avoid duplication, you can add any new contact information to existing contacts in a single action.

Touch the contact which you want to add information to, touch  and touch **Link**.

At this time, you are required to select the contact whose information you want to merge with the first contact. The information from the second contact is added to the first one, and the second contact will no longer be displayed in the Contacts list.

To separate contact information, touch the contact whose information you want to separate, then touch  and touch **View linked contacts**, Touch **SEPARATE** to confirm.

### 3.3.8 Synchronising contacts in multiple accounts

Contacts, data or other information can be synchronised from multiple accounts, depending on the applications installed on your phone.

To add an account, touch **⋮** from the contacts list and touch **Settings > Accounts > Add account**, or from the app list, touch **Settings > Accounts > Add account**.

You are required to select the kind of account you are adding, like Google, Corporate, etc.

As with other account setups, you need to enter detailed information, like username, password, etc.

You can remove an account and all associated information from the phone. Touch the account you want to delete > Touch **Remove account > Remove account**.

#### Auto-sync

On the **Accounts** screen, touch **Automatically-sync data**, when activated, all changes to information on the phone or online will be automatically synchronised with each other.

## 4 Messages .....

### 4.1 Write a new message

You can create, edit and receive SMS and MMS with this phone.

To access Messages, touch .

On the message list screen, touch  to write text/multimedia messages.

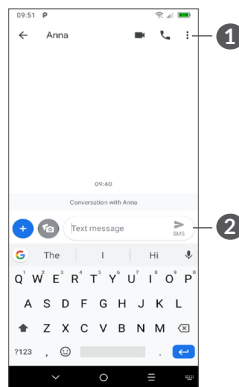

1 More options

2 Send the text message

## Sending a text message

To add recipients, enter the name or phone number of the recipient in the **To** bar. Touch the **Text message** bar to enter the text of the message. When finished, touch  to send the text message.

SMS



Specific letters (accented) will also increase the size of the SMS. This may cause multiple SMS to be sent to your recipient.

## Sending a multimedia message

MMS enables you to send video clips, images, photos, animations, slides and sounds to other compatible mobiles and email addresses.

An SMS will be converted to MMS automatically when media files (image, video, audio, etc.) are attached or subject or email addresses are added.

To send a multimedia message, enter the recipient's phone number in the **To** bar. Touch the **Text message** bar to enter the text of the message.

Touch  to attach a picture, video, audio, etc.

When finished, touch  to send the multimedia message.

## 4.2 Manage messages

When receiving a message,  will appear on the Status bar as a notification. Drag down the Status bar to open the Notification panel. Touch the new message to open and read it. You can also access the Messages application and touch the message to open it.

Messages are displayed as a conversation.

Touch a message to enter the message composing screen:

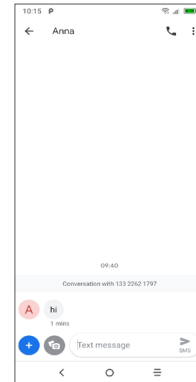

- Touch  to call the number;

To adjust message settings, touch  and select **Settings** on the message list screen.



# 5 Calendar, Clock, and Calculator.....

## 5.1 Calendar.....

You can use **Calendar** to keep track of important meetings, appointments, etc.

To view the calendar and create events, touch  from the Home screen, then touch **Calendar**.

### 5.1.1 Multimode view

You can display the Calendar by **Schedule**, **Day**, **3-day**, **Week**, or **Month**, touch  to select.

### 5.1.2 To create new events



You can add new events from any Calendar view.

- Touch .
- Fill in all required information for this new event. If it is a whole-day event, you can select **All-day**.
- Invite guests to the event. Enter the email addresses of the guests you want to invite with commas to separate. The guests will receive an invitation from Calendar and Email.

- When finished, touch **SAVE** from the top of the screen.

To quickly create an event from the Week view screens, touch an empty spot to select a target area which will then turn into , then touch the icon to create the new event.

### 5.1.3 To delete or edit an event

To delete or edit an event, touch the event to enter its details screen. Touch  to edit the event, or touch  and then **Delete** to delete.

### 5.1.4 Event reminder

If a reminder is set for an event, the upcoming event icon  will appear on the Status bar as a notification when the reminder time arrives.

Touch left and drag down the Status bar to open the Notification panel and touch an event name to view the Calendar notification list.

Touch the **Back** button to keep the reminders pending in the Status bar and the Notification panel.

## 5.2 Clock.....

Your mobile phone has a built-in clock.

To view the current time, touch  from the Home screen, then touch **Clock**.

### 5.2.1 Alarm

From the Clock screen, touch  to enter the **Alarm** screen.

Turn on  to enable the alarm.

Touch  to add a new alarm:

Touch a currently existing alarm to enter the alarm editing screen.

Touch  to delete the selected alarm.

### 5.2.2 Clock

To view the date and time, touch  on the Clock screen.

Touch  to choose a city.

## 5.2.3 Timer

From the Clock screen, touch  to enter the **Timer** screen.

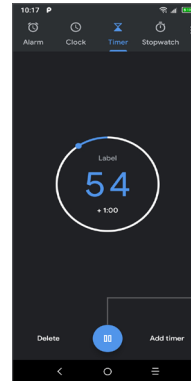

- Enter the time. The time should be typed in second, minute and hour number sequence.
- Touch  to start the countdown.



Pause/play

## 5.2.4 Stopwatch

From the Clock screen, touch  to enter the **Stopwatch** screen.

- Touch  to start the Stopwatch.
- Touch **Lap** to show a list of records according to the updated time.
- Touch  to halt the total and lap times. These will only restart after  is touched.
- Touch **Reset** to delete the record.
- Touch **Share** to share.

## 5.2.5 Adjust Clock settings

Touch  and then **Settings** to access **Clock** and **Alarms** settings.

## 5.3 Calculator .....



There are two panels available: Basic panel and Advanced panel.

Touch  to switch between panels, select one of the following two ways:

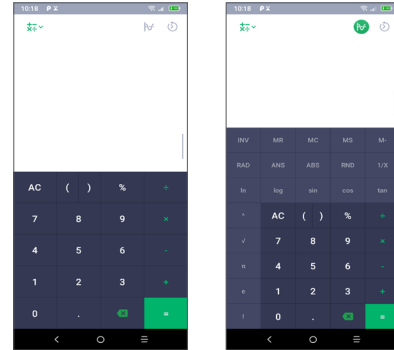

Touch  to delete digits one by one.

# 6 Getting connected.....

To connect to the internet with this phone, you can use GPRS/EDGE/3G/4G networks or Wi-Fi, whichever is most convenient.

## 6.1 Connecting to the internet

### 6.1.1 GPRS/EDGE/3G/4G

The first time you turn on your phone with your SIM card inserted, it will automatically configure your network service: GPRS, EDGE , 3G or 4G.

If the network is not connected, you can turn on mobile data in **Settings > Network & connection > Data usage**.

To check the network connection you are using, touch **Settings > Network & connection > Mobile network > Access Point Names** or **Network operators**.

#### To create a new access point

A new GPRS/EDGE/3G/4G network connection can be added to your phone with the following steps:

- Touch **Settings > Network & connection > Mobile network > Access Point Names**.
- Touch **+** and enter the required APN information.

- When finished, touch  and then **Save**.

#### To enable data roaming

- Touch **Settings > Network & connection > Mobile network > Data roaming**.
- When data roaming is disabled, you can still perform data exchange with a Wi-Fi connection (refer to "6.1.2 Wi-Fi").

#### To set preferred network mode

- Touch **Settings > Network & connection > Mobile network > Preferred networks**.

### 6.1.2 Wi-Fi

You can connect to the internet when your phone is within range of a wireless network. Wi-Fi can be used on your phone even without a SIM card inserted.

#### To turn Wi-Fi on and connect to a wireless network

- Touch **Settings > Network & connection > Wi-Fi**.
- Turn on .
- Once Wi-Fi is turned on, detected Wi-Fi networks are listed.

- Touch a Wi-Fi network to connect to it. If the network you selected is secured, you are required to enter a password or other credentials (you may contact the network operator for details). When finished, touch **CONNECT**.

### To add a Wi-Fi network

When Wi-Fi is on, you may add new Wi-Fi networks according to your preference.

- Touch **Settings > Network & connection > Wi-Fi**.
- Touch **Add network**.
- Enter the name of the network and any required network information.
- Touch **SAVE**.

### To forget a Wi-Fi network

The following steps prevent automatic connections to networks which you no longer wish to use.

- Turn on Wi-Fi, if it's not already on.
- On the Wi-Fi screen, touch the name of the saved network.
- Touch **FORGET** in the dialog that opens.

## 6.2 Connecting to a Bluetooth device <sup>(1)</sup>

Bluetooth is a short-range wireless communication technology that you can use to exchange data, or connect to other Bluetooth devices for various uses.

### To turn on Bluetooth

- Touch **Settings > Network & connection > Bluetooth**.
- Turn on **Bluetooth** .

Your device name and other available devices will appear on screen.

### To rename your device

- Touch **Settings > Network & connection > Bluetooth**.
- Touch Device name.
- Enter a name, and touch **RENAME** to confirm.

### To pair/connect your phone with a Bluetooth device

To exchange data with another device, you need to turn Bluetooth on and pair your phone with the Bluetooth device with which you want to exchange data.

- Touch **Settings > Network & connection > Bluetooth**.
- Touch **+ Pair new device**.

<sup>(1)</sup> You are recommended to use alcatel Bluetooth headsets, which have been tested and proved compatible with your phone. You can go to [www.alcatelmobile.com](http://www.alcatelmobile.com) for more information about the alcatel Bluetooth headset.

- Touch a Bluetooth device you want to pair your phone with in the list.
- In the dialog that pops up, touch **PAIR** to confirm.
- If the pairing is successful, your phone will be connected to the device.

#### To unpair from a Bluetooth device

- Touch  beside the device you want to unpair.
- Touch **FORGET** to confirm.

## 6.3 Connecting to a computer via USB

With a USB cable, you can transfer media files and other files between your phone and a computer.

#### To connect your phone to the computer

Use the USB cable that came with your phone to connect the phone to a USB port on your computer. You will receive a notification that the USB is connected.

Open the Notification panel and touch **USB charging this device**, then, in the next dialogue, choose the way in which you want to transfer files. By default, **Charge this device** is selected.



Before using MTP, make sure that the driver (Windows Media Player 11 or higher version) has been installed.

## 6.4 Sharing your phone's mobile data connection

You can share your phone's mobile data connection with a single computer via a USB cable (USB tethering) or with up to four devices at once via Bluetooth (Bluetooth tethering) or Wi-Fi (mobile hotspot).



The functions below may incur additional network charges from your network operator. Extra fees may also be charged in roaming areas.

#### To share your phone's data connection via USB and Bluetooth, or as a mobile hotspot

Go to **Settings > Network & connection > Hotspot & tethering** to activate these functions.

#### To rename or secure your mobile hotspot

When mobile hotspot is activated, you can rename your phone's Wi-Fi network (SSID) and secure its Wi-Fi network.

- Touch **Settings > Network & connection > Hotspot & tethering > Mobile hotspot**.
- Touch **Set up mobile hotspot** to rename the network SSID or set your network security.
- Touch **SAVE**.

## 6.5 Connecting to virtual private networks

Virtual private networks (VPNs) allow you to connect to the resources inside a secured local network from outside that network. VPNs are commonly deployed by corporations, schools, and other institutions so that their users can access local network resources when not inside that network, or when connected to a wireless network.

### To add a VPN

- Touch **Settings > Network & connection > VPN** and then touch **+**.
- On the screen that opens, follow your network administrator's instructions to configure each component of the VPN settings.
- Touch **SAVE**.

The VPN is added to the list on the VPN settings screen.



Before adding a VPN, you should set a screen lock for your phone.

### To connect/disconnect to/from VPN

To connect to a VPN:

- Touch **Settings > Network & connection > VPN**.

- The VPNs you have added are listed. Touch the VPN you want to connect with.
- In the dialog that opens, enter any requested credentials and touch **CONNECT**.

To disconnect from a VPN:

- Touch the VPN you want to disconnect from. In the dialog that opens, touch **DISCONNECT**.

### To edit/delete a VPN

To edit a VPN:

- Touch **Settings > Network & connection > VPN**.
- The VPNs you have added are listed. Touch the  icon next to the VPN you want to edit.
- After editing, touch **SAVE**.

To delete a VPN:

- Touch the  icon next to the selected VPN, then touch **FORGET** to delete it.

# 7 Multimedia applications.....

## 7.1 Camera.....

Your mobile phone is fitted with a camera for taking photos and videos.

Before using the camera, make sure that you remove the protective lens cover to avoid it affecting your picture quality.

To take a photo or video, touch **Camera** from the Favourites tray.

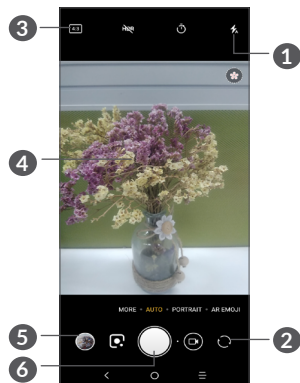

### 1 Flash mode

Touch to turn on/off the camera flash.

### 2 Switch between front/back camera



### 3 Picture size

### 4 Pinch/spread two fingers together/apart to zoom out/in

### 5 View the photos or videos you have taken



### 6 Take a photo



### To take a photo

The screen acts as the viewfinder. First, position the object or landscape in the viewfinder, touch the screen to focus if necessary and touch  to capture. The photo will be automatically saved. You can also long press  to take burst shots.





## To take a video

Touch the right part of this icon  to change the camera mode to video, then touch the left part of this icon  to start video recording. You can also touch the left part of this icon  to take a picture during video recording.

Touch  to pause video recording and touch  to continue. Touch  to stop recording. The video will be automatically saved.

## Further operations when viewing a picture/video you have taken

- Slide left or right to view the photos or videos you have taken.
- Touch , then Gmail/Bluetooth/MMS/etc. to share the photo or video.
- Touch  to return to **Camera**.

## 7.1.1 Modes and settings

Slide left or right to switch between modes.

- *Auto*

Auto is the default mode for Camera.

- *Pano*

Touch to turn on panorama function. Touch the shutter button to start taking panoramic photo and move the phone steadily along the direction indicated by the onscreen line. Once the slots are filled, the photo will be automatically saved. If the slots are not fully filled, touch the shutter button again to save the photo.

- *Portrait*

Touch to create a depth of field effect. You can constitute an image that highlights your subject while producing a gorgeously blurred background.

### Settings

- *Grid*

Turn on  to enable grid view. It divides the screen into equal parts and helps you take better photos by making it simple to align elements, such as the horizon or buildings, to the lines in the grid.

- **Save location information**

Turn on  to tag photos and videos with your location. This option is available when the GPS location service is enabled.

## 7.2 Gallery.....

Gallery acts as a media player for you to view photos and play videos. In addition, a set of further operations to pictures and videos are available for your choice.

To view the photos you have taken, touch **Gallery** from the Home screen.

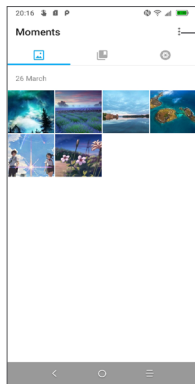

Select photos for further operation.



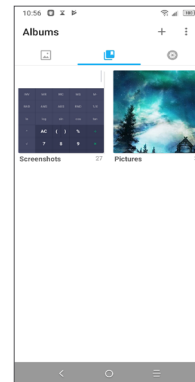

### To view a picture/play a video

Pictures and videos are displayed by albums in the **Gallery**.



### Working with pictures

You can work with pictures by rotating or cropping them, sharing them with friends, setting them as a contact photo or wallpaper, etc.

Find the picture you want to work on, and touch the picture in the full-screen picture view. Touch  to share the picture, or  to edit the picture. Touch  to set the picture as your favourite. Touch  to delete this picture and select **Set as...** to set the picture as Contact photo or Wallpaper.

Touch  in the full-screen picture view to edit a picture through **Editor (Default)** or other editors.

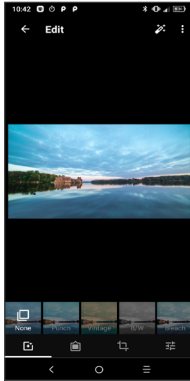

- ✂ Set effects such as **Punch, Vintage, B/W, Bleach**, etc.
- 🖼 Add a border.
- 📐 **Crop, Straighten, Rotate, Mirror or Draw** the picture.
- 🎨 Adjust the picture colour.

## Batch operation

The Gallery provides a multi-select function, so that you can work with pictures/videos in batches.

On **Moments** screen , touch **⋮** and touch **Select items** to activate batch operation mode (you can also long press one album/picture), then touch videos/pictures you want to work with. Touch **🗑** to delete selected files. Touch **🔗** to share selected files.

## 8 Others.....

### 8.1 Radio.....

Your phone is equipped with a radio <sup>(1)</sup> with RDS <sup>(2)</sup> functionality. You can use the application as a traditional radio with saved channels or with visual information related to the radio programme displayed if you turn to stations that offer Visual Radio service.

To listen to a radio programme, touch  from the app list, then touch **Radio**.

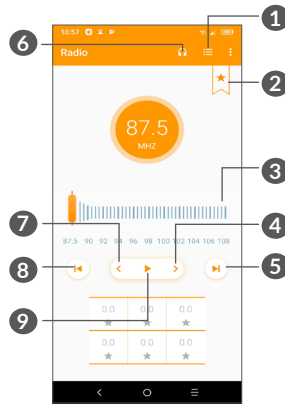

- 1 Touch to open and view the saved channels list.
- 2 Touch to add the current station to favourites.
- 3 Drag to change current frequency.
- 4 Touch to increase 0.1MHz. Long press to search and go to the nearest higher frequency channel.
- 5 Touch to go to next saved channel.
- 6 Touch to enable/disable the loudspeaker.
- 7 Touch to decrease 0.1MHz. Long press to search and go to the nearest lower frequency channel.
- 8 Touch to go to previous saved channel.
- 9 Touch to play/stop.

<sup>(1)</sup> The quality of the radio depends on the coverage of the radio station in that particular area.

<sup>(2)</sup> Depending on your network operator and market.



To listen to the radio you must insert headphones. Headphones act as radio antenna.

#### Available options:

- *Save channels*  
Touch to add the current station to favourites. It will disappear if the current channel has been saved.
- *Scan channels*  
Touch to search for channels.
- *Delete*  
Delete the channel.
- *Enter frequency*  
Enter the frequency manually to turn to the channel.
- *Station info*  
Mark the checkbox to display station information.
- *Exit*  
Turn off the radio.

## 8.2 Support Centre.....



**Support Centre** helps you to learn more about Hot FAQs, operation instructions, troubleshooting, etc. You can also feedback your comments to us through it.

## 8.3 Other applications <sup>(1)</sup>

The previous applications in this section are preinstalled on your phone. To read a brief introduction of the preinstalled 3rd party applications, refer to the leaflet provided with the phone. To download and install more 3rd party applications, use the Google Play Store application.

<sup>(1)</sup> Application availability depends on country and operator.

# 9 Google applications .....

Google apps are preinstalled on your phone to improve work efficiency and help you enjoy life.

This manual briefly introduces the apps. For detailed features and user guides, refer to related websites or the introduction provided in the apps.

You are recommended to register with a Google account to enjoy all the functions.

## 9.1 Chrome

A web browser with which you can surf the internet.

Your bookmarks, browsing history, and settings across all devices with the browser installed can be synchronised with your Google account.

## 9.2 Gmail

As Google's web-based email service, Gmail is configured when you first set up your phone. With this application, you can send and receive emails, manage emails by labels, archive emails, etc. Emails can be automatically synchronised with your Gmail account.

## 9.3 Maps

Google Maps offers satellite imagery, street maps, 360° panoramic views of streets, real-time traffic conditions, and route planning for travelling by foot, car, or public transportation. By using this application, you can get your own location, search for a place, and get suggested route planning for your trips.

## 9.4 YouTube

YouTube is an online video-sharing application where users can upload, view, and share videos. Available content includes video clips, TV clips, music videos, and other content such as video blogging, short original videos, and educational videos. It supports a streaming function that allows you to start watching videos almost as soon as they begin downloading from the internet.

## 9.5 Play Store

Serves as the official app store for the Android operating system, allowing users to browse and download applications and games. Applications are either free of charge or at a cost.

In Play Store, search for the app you need, download it and then follow the installation guide to install the app. You can also uninstall, update an app, and manage your downloads.

## 9.6 Play Music

A music streaming service and online music locker operated by Google.

You can download and listen to a large number of songs for a monthly fee. In addition to offering music streaming for internet-connected devices, the Google Play Music app allows music to be stored and listened to offline. Songs purchased through Play Music are automatically added to the user's account.

# 10 Settings.....

To go to Settings, touch **Settings** from the app list.

## 10.1 Network & connection

### 10.1.1 Wi-Fi

Using Wi-Fi you can access the internet without using your SIM card whenever you are in range of a wireless network. The only thing you have to do is to enter the **Wi-Fi** screen and configure an access point to connect your phone to the wireless network.

For detailed instructions on using Wi-Fi, refer to "**6.1.2 Wi-Fi**".

### 10.1.2 Bluetooth

Bluetooth allows your phone to exchange data (videos, images, music, etc.) within a small range with another Bluetooth supported device (phone, computer, printer, headset, car kit, etc.).

For more information on Bluetooth, refer to "**6.2 Connecting to a Bluetooth device**".

### 10.1.3 NFC <sup>(1)</sup>

NFC allows data exchange when the phone touches another device.

### 10.1.4 Mobile network

You can set **Data roaming**, **Preferred network type**, **Access Point Names**, and **Network operators** in this menu.

### 10.1.5 Data usage

#### Data saver

By enabling Data saver, you can reduce data usage by preventing some apps from sending or receiving data in the background.

#### Mobile data

If you do not need to transmit data on mobile networks, turn off **Mobile data** to avoid incurring significant charges for data use on local operator mobile networks, particularly if you do not have a mobile data agreement.



Data usage is measured by your phone, and your operator may count differently.

<sup>(1)</sup> 5053Y/5053K only.

### 10.1.6 Hotspot & tethering

This function allows you to share your phone's mobile data connection via USB or as a portable Wi-Fi access point (refer to "**6.4 Sharing your phone's mobile data connection**").

### 10.1.7 SIM cards <sup>(1)</sup>

Touch to choose SIM 1 or SIM 2 for connecting to the network, making calls and sending SMS messages.

### 10.1.8 VPN

For more information on VPN, refer to "**6.5 Connecting to virtual private networks**".

### 10.1.9 Aeroplane mode

Turn on **Aeroplane mode**  to simultaneously disable all wireless connections including Wi-Fi, Bluetooth and more.

### 10.1.10 USB

You can use USB to **Charge this device**, **Transfer files or Transfer photos (PTP)**.

<sup>(1)</sup> Dual SIM only.



### 10.1.11 Printing

Touch **Printing** to activate **Print services**. You can select your **Default print service** or choose **Add service**.

## 10.2 Display

In this menu, you can adjust your **Home app**, **Brightness level**, **Eye comfort mode**, **Wallpaper**, **Sleep**, **Font size**, etc.

To rotate screen contents when device is rotated, touch **Auto-rotate screen**.

## 10.3 Security & location

Touch to set **Device security** such as **Screen lock**, **Fingerprint sensor**, **Face key**, **Apps lock**, **Lock screen preferences**, **Smart Lock**, and **Privacy**, **Security status**.

## 10.4 Advanced Features

Touch to set **App Cloner**, **Screen Recorder**, **Func shortcuts**, **Gestures**, and **One-handed mode**.

## 10.5 Apps

Touch to view details about the applications installed on your phone, to manage their data usage or force them to stop.

In the **App permissions** menu of an application, you can grant permissions for the app, such as allowing the app to access your **Camera**, **Contacts**, **Location**, etc.

## 10.6 Smart Manager

Restrict auto-start apps can make system run faster and extend battery life.

## 10.7 Sound

Touch to adjust call and notification ringtones, music, and other audio settings.

## 10.8 Accounts

Touch to add, remove, and manage your email and other supported accounts. You can also use these settings to control how and whether all applications send, receive, and synchronise data on their own schedules, and whether all applications can synchronise user data automatically.

Touch **Add account** to add an account for the selected app.

## 10.9 Google

Touch to configure your Google account and services settings.

## 10.10 Accessibility

Use the Accessibility settings to configure any accessibility plug-ins you have installed on your phone.

## 10.11 System

### 10.11.1 Updates

If you want to update the system, touch , and then touch **CHECK FOR UPDATES NOW** (refer to "11.1 FOTA Upgrade").

### 10.11.2 Update APPS

If you want to update the apps, touch  to check for updates.

### 10.11.3 Languages & input

Touch to configure language settings, the on-screen keyboard, voice input settings, pointer speed, etc.

### 10.11.4 Date & time

Use Date & time settings to customise your preferences for how date and time are displayed.

## 10.11.5 Backup

Turn on  to back up your phone's settings and other application data to Google servers. If you replace your phone, the settings and data you've backed up will be restored onto the new phone when you sign in with your Google account. If you mark this option, a wide variety of settings and data are backed up, including your Wi-Fi passwords, bookmarks, a list of the applications you've installed, the words you've added to the dictionary used by the onscreen keyboard, and most of the settings that you configure in the Settings application. If you unmark this option, you stop backing up your settings, and any existing backups are deleted from Google servers.

### 10.11.6 Developer options

To enable this function, go to **Settings > System > About phone**, then touch **Build number** 7 times. Now **Developer options** is available. The developer options screen contains settings that are useful for developing Android applications.

### 10.11.7 Reset

Touch to choose **Network settings reset (including Wi-Fi, Mobile data & Bluetooth)**, Reset app preferences, or **Factory data reset**.

### 10.11.8 Regulatory & safety

Touch to view product information such as **Product model**, **Manufacturer name**, **Manufacturer address**, **IMEI**, **CU reference**, **Bluetooth Declaration ID**.

### 10.11.9 About phone

This contains information such as **TCTROM**, **Status**, **Legal information**, **Privacy policy**, **Model**, **Android version**, **Android security patch level**, **Baseband version**, **Kernel version**, **Build number**, **User Manual**, etc.

# 11 Making the most of your phone .....

## 11.1 FOTA Upgrade

Use the FOTA (Firmware Over The Air) Upgrade tool to update your phone's software. To access **Updates**, from the app list, touch **Settings > System > Updates**.

If you want to update the system, touch **CHECK FOR UPDATES NOW** and when that's finished, your phone will have the latest version of the software. Turn on data connection or Wi-Fi before searching for updates. Settings for auto-check frequency are also available once you restart the phone. If you have chosen auto-check, when the system discovers the new version, a dialog will pop up where you can choose to download the update or ignore. A notification will also appear in the Status bar.

During FOTA downloading or updating, to avoid errors in locating the correct update packages, do not change your default storage location.

## 12 Accessories .....

### Standard accessories

1. Charger
2. WH15
3. Quick Start Guide
4. Product safety information leaflet
5. LCD sticker
6. Battery



- Accessories depend on countries.
- Only use the alcatel batteries, chargers, and accessories included along with your device.

## 13 Warranty .....

Your phone is warranted against any defect or malfunctioning which may occur in conditions of normal use during the warranty period of twelve (12) months <sup>(1)</sup> from the date of purchase as shown on your original invoice.

Batteries <sup>(2)</sup> and accessories sold with your phone are also warranted against any defect which may occur during the first six (6) months <sup>(1)</sup> from the date of purchase as shown on your original invoice.

In case of any defect of your phone which prevents you from normal use thereof, you must immediately inform your vendor and present your phone with your proof of purchase.

<sup>(1)</sup> The warranty period may vary depending on your country.

<sup>(2)</sup> The life of a rechargeable phone battery in terms of conversation time, standby time and total service life, will depend on the conditions of use and network configuration. Batteries being considered expendable supplies, the specifications state that you should obtain optimal performance for your phone during the first six months after purchase and for approximately 200 more recharges.

If the defect is confirmed, your phone or part thereof will be either replaced or repaired, as appropriate. Repaired phone and accessories are entitled to a one (1) month warranty for the same defect. Repair or replacement may be carried out using reconditioned components offering equivalent functionality.

This warranty covers the cost of parts and labor but excludes any other costs.

This warranty shall not apply to defects to your phone and/or accessory due to (without any limitation):

- Non-compliance with the instructions for use or installation, or with technical and safety standards applicable in the geographical area where your phone is used;
- Connection to any equipment not supplied or not recommended by TCL Communication Ltd.;
- Modification or repair performed by individuals not authorised by TCL Communication Ltd. or its affiliates or your vendor;
- Modification, adjustment or alteration of software or hardware performed by individuals not authorised by TCL Communication Ltd.;
- Inclement weather, lightning, fire, humidity, infiltration of liquids or foods, chemical products, download of files, crash, high voltage, corrosion, oxidation...

Your phone will not be repaired in cases where labels or serial numbers (IMEI) have been removed or altered.

There are no express warranties, whether written, oral or implied, other than this printed limited warranty or the mandatory warranty provided by your country or jurisdiction.

In no event shall TCL Communication Ltd. or any of its affiliates be liable for indirect, incidental or consequential damages of any nature whatsoever, including but not limited to commercial or financial loss or damage, loss of data or loss of image to the full extent those damages can be disclaimed by law.

Some countries/states do not allow the exclusion or limitation of indirect, incidental or consequential damages, or limitation of the duration of implied warranties, so the preceding limitations or exclusions may not apply to you.

# 14 Troubleshooting.....

Before contacting the service center, here are some instructions to help you troubleshoot your device:

- For optimal operation, fully charge the battery.
- To improve the phone's performance, remove unnecessary files or apps on your phone.
- Update your phone's software via the **Update APPS** application. Or you can touch **Settings > System > Update APPS** to update software.
- Reset your phone via **Factory data reset**. Touch **Settings > System > Reset > Factory data reset**. Another method is to hold down the **Power** key and the **Volume up** key at the same time when your phone is powered off. All your phone data will be lost permanently. It is strongly advised to fully back up your phone data before resetting.

and carry out the following checks:

## **My phone can't be switched on or is frozen**

- When the phone can't be switched on, charge for at least 20 minutes to ensure the minimum battery power needed. Then switch it on again.

- When the phone falls into a loop during power on animation and the user interface can't be accessed, press and hold the **Power** key to reset. This eliminates any abnormal OS booting issues caused by third party applications.
- If neither method is effective, reset the phone by pressing the **Power** key and the **Volume up** key at the same time, selecting a language, and then selecting **Wipe data/Factory reset**. Press the **Volume** key to select, and press the **Power** key to confirm each selection.

## **My phone has not responded for several minutes**

- If your phone doesn't respond, turn off your phone by pressing and holding the **Power** key until it turns off and then restart it again.
- If your phone has a removable battery, remove the battery and reinsert it, then restart the phone.
- If it still doesn't work, reset the phone.

## **My phone turns off by itself**

- Check that your screen is locked when you are not using your phone, and make sure that the **Power** key is not accidentally pressed while the screen is unlocked.
- Check the battery charge level.
- If it still doesn't work, reset the phone or update software.

### **My phone can't charge properly**

- Make sure that you are using the **Alcatel** charger that comes with the phone.
- If your phone has a removable battery, make sure that your battery is inserted properly and clean the battery contact if it's dirty. It must be inserted before plugging in the charger.
- Make sure that your battery is not completely discharged; if the battery power has been empty for a long time, it may take around 20 minutes to display the battery charging indicator on the screen.
- Make sure that charging is carried out under normal conditions (0°C (32°F) to 40°C (104°F)).
- When abroad, check that the voltage input is compatible.

### **My phone can't connect to a network or "No service" is displayed**

- Try connecting to the network by moving to another physical location.
- Verify the network coverage with your operator.
- Check with your operator that your SIM card is valid.
- Try connecting at a later time if the network is overloaded.

### **My phone can't connect to the internet**

- Make sure that the internet access service of your SIM card is available.
- Check your phone's internet connection settings.
- Make sure that you are in a place with network coverage.
- Try connecting at a later time or another location.

### **Invalid SIM card**

- Make sure that the SIM card has been correctly inserted.
- Make sure that the chip on your SIM card is not damaged.
- Make sure that the service of your SIM card is available.

### **My phone can't make outgoing calls**

- Make sure that you have dialled a valid number and have touched **Call**.
- For international calls, check the country and area codes.
- Make sure that your phone is connected to a network, and the network is not overloaded or unavailable.
- Check your subscription status with your operator (credit, SIM card valid, etc.).
- Make sure that you have not barred outgoing calls.

- Make sure that your phone is not in aeroplane mode.

### **My phone can't receive incoming calls**

- Make sure that your phone is switched on and connected to a network (check for overloaded or unavailable network).
- Check your subscription status with your operator (credit, SIM card valid, etc.).
- Make sure that you have not forwarded incoming calls.
- Make sure that you have not barred certain calls.
- Make sure that your phone is not in aeroplane mode.

### **The caller's name/number doesn't appear when a call is received**

- Check that you have subscribed to this service with your operator.
- Your caller may have concealed his name or number.

### **I can't find my contacts**

- Make sure that your SIM card is not broken.
- Make sure that your SIM card is inserted properly.
- Import all contacts stored in SIM card to phone.

### **The sound quality of the calls is poor**

- Adjust the volume during a call by pressing the **Volume** key.

- Check the network strength. Move to a location with stronger signal strength.
- Make sure that the receiver, connector and speaker on your phone are clean.

### **I can't use the features described in the manual**

- Check with your operator to make sure that your subscription includes this service.
- Make sure that this feature doesn't require an **Alcatel** accessory.

### **When I select a number from my contacts, the number can't be dialled**

- Make sure that you have correctly recorded the number in your file.
- Make sure that you have selected the country code when calling an international number.

### **I can't add a contact**

- Make sure that your SIM card contacts are not full; delete some files or save the files to the phone.

### **My callers can't leave messages on my voicemail**

- Contact your network operator to check service availability.

### **I can't access my voicemail**

- Make sure that your operator's voicemail number is correctly entered in "Voicemail number".
- Try later if the network is busy.



### **I can't send and receive MMS**

- Check your phone storage as it might be full.
- Contact your network operator to check service availability and MMS parameters.
- Verify the server centre number or your MMS profile with your operator.
- The server centre may be swamped. Try again later.

### **SIM card PIN locked**

- Contact your network operator to obtain the PUK (Personal Unblocking Key) code.

### **I can't connect my phone to my computer**

- Check to make sure the USB port is not broken. If it's not working, try another USB port on your computer.
- Make sure USB drivers are properly installed.
- If you are using a Windows computer, make sure it supports MTP mode. If you are using a Mac, make sure to install Android File Transfer from [www.android.com/filetransfer/](http://www.android.com/filetransfer/).

### **I can't download new files**

- Make sure that there is sufficient phone storage space for your download.
- Select the microSD card as the location to store downloaded files.
- Check your subscription status with your operator.

### **The phone can't be detected by others via Bluetooth**

- Make sure that Bluetooth is turned on and your phone is visible to other users.
- Make sure that the two phones are within Bluetooth's detection range.

### **The battery drains too fast**

- Make sure that you follow the complete charge time (minimum 150 minutes).
- After a partial charge, the battery level indicator may not be exact. Wait for at least 20 minutes after removing the charger to obtain an exact indication.
- Adjust the brightness of screen as appropriate.
- Extend the email auto-check interval for as long as possible.
- Update news and weather information on manual demand, or increase their auto-check interval.
- Exit background-running applications if they are not being used for extended periods of time.
- Turn off Bluetooth, Wi-Fi, or GPS when not in use.

### **The phone becomes warm following prolonged calls, game playing, internet surfing or running other complex applications**

- This heating is a normal consequence of the CPU handling excessive data. Ending the above actions will make your phone return to normal temperature.

## After a factory data reset is performed, I can't use my phone without entering Google account credentials

- After a reset is performed, you must enter the original Google account credentials that were used on this phone.
- If you don't remember your Google account credentials, complete Google account recovery procedures.
- If you still cannot access your phone, apply to the authorised repair centre, but remember that it will not be regarded as warranty case.

## I forget some passwords/codes/keys on phone

- Perform a factory data reset.
- If you still cannot access your phone, apply to the authorised repair centre, but remember that it will not be regarded as a warranty case.

# 15 Specifications.....

## Processor :

SDM439

## Platform :

Android O

## Memory :

5053D/Y: 32GB+3GB, 5053K: 64GB+4GB

## Dimensions (LxWxT) :

151.1x69.7x7.99mm

## Weight :

145g

## Display :

5.94-inch touchscreen with HD+ 19.5:9 (720X1560)

## Network :

GSM: 850/900/1800/1900

UMTS: B1/2/5/8 (2100/1900/850/900)

LTE: 1/3/7/8/20/28  
(2100/1800/2600/900/800/700)

(Band frequency and data speed are operator dependent.)

**GPS :**

GPS

**Connectivity :**

- Bluetooth BT4.2
- Wi-Fi 802.11b/g/n (2.4GHz)
- 3.5 mm audio jack
- micro-USB

**Camera :**

- Up to 13+5 megapixel back camera by SW
- Up to 8 megapixel front camera by SW

**Audio supported formats :**

AAC, AMR, AWB, MP3, AAC+, Vorbis, FLAC, APE, AIFF, eAAC+, PCM playback

**Battery <sup>(1)</sup> :**

Capacity: 3500 mAh

**Expansion Slot :**

microSD™ memory card  
(Availability of microSD card depends on market)

**Special Features :**

- GPS
- G-sensor

**Note:** Specifications are subject to change without prior notice.

<sup>(1)</sup> The original battery has undergone rigorous safety inspections to meet qualification standards, the use of non-original batteries may be dangerous.

